

IK-766SS-BPT SERIES

Auto-Cleaning Oxidizer + pH + ORP + Conductivity Analyzers



OXIPANEL
PLATINUM



Related Statements

The manufacturer shall not be liable for direct, indirect, special, incidental or consequential damages resulting from any deficiency or omission in this manual. The manufacturer reserves the right to make changes to this manual and the products described in it at any time without notice or liability. Revised versions can be found on the manufacturer's website.

Safety Information

Please read this manual completely before unpacking, installing and operating this equipment. In particular, pay attention to all dangers, warnings and precautions, otherwise, it may cause serious personal injury to the operator or damage to the equipment.

Use of Danger Information

 Danger
Indicates a potentially or urgent dangerous situation that, if not avoided, will cause death or serious injury.
 Warning
Indicates a potentially or very dangerous situation that, if not avoided, may cause serious personal injury or death.
 Warning
Indicates a potentially dangerous situation that may cause a certain degree of personal injury.
Attention
Indicates conditions that if not avoided, will cause damage to the instrument. This is information that needs special emphasis.

Warning Label

Please read all labels and marks attached to the instrument. Failure to follow the instructions on these safety labels may result in personal injury or damage to the instrument.





	If this symbol appears in the instrument, it means refer to the operation and/or safety information in the instruction manual.
	If there is this mark on the instrument housing or insulator, it means there is a risk of electric shock or death from electric shock.
	Static electricity can damage the delicate internal electronic components, resulting in reduced performance or eventual failure of the instrument.
	Electrical equipment marked with this symbol cannot be disposed of through the European public waste system after August 12, 2005. In order to comply with European regional and national regulations (EU Directive 2002 / 98 / EC), European electrical equipment users must now return abandoned or expired equipment to the manufacturer for disposal without any cost.

Table of Contents

1. Specifications	- 1 -
2. Features	- 3 -
3. Order Information	- 4 -
4. Analyzer Dimension and Mounting	- 5 -
5. Analyzer Installation	- 5 -
5.1. Installation Requirements.....	- 5 -
5.2. Sample Water Connection	- 6 -
5.3. Terminal Board Wiring	- 7 -
6. Analyzer Components & Dimensions	- 9 -
6.1. UC-80-PLUS Display & Data Logging Terminal (mm)	- 9 -
6.2. FS-100 Ultrasonic Flow Meter (mm)	- 9 -
6.3. FR-306-PLUS Automatic Brushing Flow Assembly (mm)	- 10 -
6.4. ST-766SS Series Sensor (mm)	- 10 -
7. FS-100 Flow Control Module Overview & Use	- 11 -
7.1. FS-100 Key Function	- 11 -
7.2. FS-100 Main Screen	- 12 -
7.3. FS-100 Flow Trend Chart.....	- 12 -
7.4. FS-100 - Setting the C-Mode for the Sample Flow Control.....	- 13 -
7.5. FS-100 Modbus Communication Settings	- 14 -
7.6. FS-100 Factory Reset.....	- 14 -
7.7. FS-100 Device Information & Diagnosis	- 15 -
8. UC-80-PLUS Display Touch Screen Operation	- 15 -
8.1. Main Screen.....	- 15 -
8.2. User Login & Password	- 16 -
8.3. Real-Time Monitoring.....	- 16 -
8.4. Explanation and use of the Output Signal HOLD Feature	- 20 -
8.5. Menu Bar	- 21 -
8.6. Configurable Parameters.....	- 21 -
8.6.1. Control Interface.....	- 22 -
8.6.2. Settings Interface.....	- 34 -
8.6.3. User Defined Settings.....	- 36 -
8.6.4. Information Service.....	- 38 -

8.6.5.	4-20mA Input.....	- 41 -
8.6.6.	DCS Output.....	- 42 -
8.7.	ST-766SS Series Sensor Calibration.....	- 43 -
8.7.1.	pH Calibration.....	- 44 -
8.7.2.	Oxidizer Calibration.....	- 46 -
8.7.3.	ORP Calibration.....	- 47 -
8.7.4.	Conductivity Calibration.....	- 48 -
8.7.5.	Recovering Data.....	- 49 -
8.8.	Alarm View	- 49 -
8.9.	Historical Data - Query, View & USB Download.....	- 50 -
8.10.	Historical Data Curves.....	- 53 -
8.11.	User Management.....	- 54 -
9.	Modbus Register Table & Analyzer Maintenance	- 55 -
9.1.	Modbus Correspondence Address.....	- 55 -
9.2.	Analyzer Operation and Maintenance.....	- 56 -
9.3.	Instrument Alarms and Descriptions.....	- 56 -
10.	Replacement Maintenance.....	- 57 -
10.1.	Replacing the FR-306-PLUS Brush Assembly.....	- 57 -
10.2.	Sensor Cleaning with Pyxis Probe Cleaning Kit.....	- 59 -



1. Specifications

Item	IK-766SS-FCL-BPT	IK-766SS-CLO-BPT	IK-766SS-Br-BPT	IK-766SS-TCL-BPT
P/N	48751	48512	47939	46990
Sensor Body Material	SS316L			
Sensor Model	ST-766SS-FCL	ST-766SS-CLO	ST-766SS-Br	ST-766SS-TCL
Electrode Head Type	EH-766			
Oxidizer Measured	Free Chlorine	Chlorine Dioxide	Bromine	Total Chlorine
Oxidizer Range	0.00-5.00 ppm			
Oxidizer Precision	± 0.01mg/L or 1% /pH compensation up to 9.0			
pH / ORP / Conductivity Range	0.00 -14.00 (± 0.01 pH) / -1,500 – +1,500 mV (±1.0 mV ORP) / 0-10,000µS/cm (±5%)			
Measurement Interval	Continuous			
Sensor Response Time	T95≤60s – Oxidant / T95≤5s – pH-ORP-Conductivity			
Sensor Installation Method	FR-306-PLUS Magnetic Coupling Brushing Flow Reservoir Included			
Sensor Flow Interlock	Sensor Powers Down when in Auto Mode if Flow <50mL/min and On >200mL/min			
Sample Operating Temperature	4 – 49°C (40 – 120°F)			
Sample Inlet Operating Pressure	7.25 –87 psi (0.05 – 0.6MPa)			
Sample Inlet/Outlet Line Size	¾ - inch OD inserted into ½-inch NPT port			
FS-100 Method of Measure	Ultrasonic Flow Detection			
FS-100 Rated Flow Range	0 – 3,000 mL/min			
FS-100 Resolution/Max Error	1mL/min or ±2% of the value			
FS-100 Display	1.44" Color 128 x128 Resolution			
Flow Regulating Valve Control	4-20mA from FS-100 (<i>internally connected</i>)			
FR-306-PLUS Suggested Flow	200 –800 mL/minute (Flow Setting Done through FS-100 interface)			
FR-306-PLUS Flow Interlock	Brush Motor Turns Off when in Auto Mode if Flow <50mL/min and On >200mL/Min			
FR-306-PLUS Rotational Speed	200 RPM – Motorized Brush			
UC-80-PLUS Display	7-inch LCD Color / Resistive Touch			
UC-80-PLUS Input	2x 4-20 mA / RS-485 Modbus – RTU			
UC-80-PLUS Output	5x 4-20 mA / RS-485 Modbus-RTU / Modbus-TCP			
UC-80-PLUS Relay	2x VAC Relays / 1x24VDC relay (Passive or Active – User Selected) / 1x Analog PID			
UC-80-PLUS Data Storage	Built-In 128MB of Ram for Storing up to 1-Million Data/Event Records			
UC-80-PLUS USB	1 x USB host, for data downloading and screen upgrade			
UC-80-PLUS Relative Humidity	20% - 90% (No Condensation)			
UC-80-PLUS Altitude	<6,561 feet (<2,000 Meter)			
Panel Power Supply	96-260VAC / 50-60 Hz; 60 W USA Type B Plug			
Panel Storage Temperature	-4 – 158 °F (-20 – 70 °C)			
Panel Dimension (H x W x D)	Panel 500H x 800W x 230D mm			
Panel Approximate Weight	Panel ~ 20 kg			
Panel Wet Material	Polycarbonate/304SS/316SS/Glass/Gold/Platinum/CPVC/PTFEPOM/ABS/PEEK/PET/NBR			
Rating	IP-65 Panel-Display / IP-67 Sensors			
Compliance	EPA 334.0 / ISO 7393			
Regulation	CE Marked / RoHS / UKCA			
Selectivity	Non-Selective, cross sensitive to other oxidizing species			
Warranty	6 Months Electrode / 13 Months Sensor Body & Panel			
Typical Electrode Service Life	2 years			
Typical FR-306-PLUS Brush Life	12-18 months depending on application of use			
Pyxis 4G CloudLink™	Included & Activated On Request with Enrollment – Contact Pyxis Lab for details			



Item	IK-766SS-NCL-BPT	IK-766SS-PAA-BPT	IK-766SS-TFCL-BPT	IK-766SS-DCL-BPT
P/N	46117	48150	42270	40759
Sensor Body Material	SS316L			
Sensor Model	ST-766SS-NCL	ST-766SS-PAA	ST-766SS-TFCL	ST-766SS-DCL
Electrode Head Type	EH-766		EH-766-01	
Oxidizer Measured	MonoChloramine	PAA	Free+Total Chlorine	Chlorine+Sulfite
Oxidizer Range	0.00-5.00 ppm	0.00-100 ppm	0.00-5.00 ppm	0.00-5.00 ppm
Oxidizer Precision	± 0.01mg/L or 1% / pH compensation up to 9.0			
Sulfite Range	Not Measured			0-100ppm
pH / ORP / Conductivity Range	0.00 -14.00 (± 0.01 pH) / -1,500 – +1,500 mV (±1.0 mV ORP) / 0-10,000µS/cm (±5%)			
Measurement Interval	Continuous			
Sensor Response Time	T95≤60s – Oxidant / T95≤5s – pH-ORP-Conductivity			
Sensor Installation Method	FR-306-PLUS Magnetic Coupling Brushing Flow Reservoir Included			
Sensor Flow Interlock	Sensor Powers Down when in Auto Mode if Flow <50mL/min and On >200mL/min			
Sample Operating Temperature	4 – 49°C (40 – 120°F)			
Sample Inlet Operating Pressure	7.25 –87 psi (0.05 – 0.6MPa)			
Sample Inlet/Outlet Line Size	¾ - inch OD inserted into ½-inch NPT port			
FS-100 Method of Measure	Ultrasonic Flow Detection			
FS-100 Rated Flow Range	0 – 3,000 mL/min			
FS-100 Resolution/Max Error	1mL/min or ±2% of the value			
FS-100 Display	1.44" Color 128 x128 Resolution			
Flow Regulating Valve Control	4-20mA from FS-100 (<i>internally connected</i>)			
FR-306-PLUS Suggested Flow	200 –800 mL/minute (Flow Setting Done through FS-100 interface)			
FR-306-PLUS Flow Interlock	Brush Motor Turns Off when in Auto Mode if Flow <50mL/min and On >200mL/Min			
FR-306-PLUS Rotational Speed	200 RPM – Motorized Brush			
UC-80-PLUS Display	7-inch LCD Color / Resistive Touch			
UC-80-PLUS Input	2x 4-20 mA /RS-485 Modbus – RTU			
UC-80-PLUS Output	5x 4-20 mA / RS-485 Modbus-RTU / Modbus-TCP			
UC-80-PLUS Relay	2x VAC Relays / 1x24VDC relay (Passive or Active – User Selected) / 1x Analog PID			
UC-80-PLUS Data Storage	Built-In 128MB of Ram for Storing up to 1-Million Data/Event Records			
UC-80-PLUS USB	1 x USB host, for data downloading and screen upgrade			
UC-80-PLUS Relative Humidity	20% - 90% (No Condensation)			
UC-80-PLUS Altitude	<6,561 feet (<2,000 Meter)			
Panel Power Supply	96-260VAC / 50-60 Hz; 60 W USA Type B Plug			
Panel Storage Temperature	-4 – 158 °F (-20 – 70 °C)			
Panel Dimension (H x W x D)	Panel 500H x 800W x 230D mm			
Panel Approximate Weight	Panel ~ 20 kg			
Panel Wet Material	Polycarbonate/304SS/316SS/Glass/Gold/Platinum/CPVC/PTFEPOM/ABS/PEEK/PET/NBR			
Rating	IP-65 Panel-Display / IP-67 Sensors			
Compliance	EPA 334.0 / ISO 7393			
Regulation	CE Marked / RoHS / UKCA			
Selectivity	Non-Selective, cross sensitive to other oxidizing species			
Warranty	6 Months Electrode / 13 Months Sensor Body & Panel			
Typical Electrode Service Life	2 years			
Typical FR-306-PLUS Brush Life	12-18 months depending on application of use			
Pyxis 4G CloudLink™	Included & Activated On Request with Enrollment – Contact Pyxis Lab for details			

2. Features

- The Pyxis ST-766SS Series are multi-parameter composite sensors used for the measurement residual Free Chlorine, Total Chlorine, Bromine, Chlorine Dioxide, Monochloramine, PAA and Sulfite as well as pH, ORP, Conductivity and Temperature in compliance with US-EPA 334.0 and ISO-7393 guidelines. The sensors advanced PCB offers built-in temperature and pH parameter compensation (up to pH 9.0+) algorithms eliminating the need for a supplemental pH sensor and controller. Unique Bare-Gold electrode technology for residual oxidizer measurement eliminates membranes and electrode solution replenishment commonly associated with conventional sensors. The ST-766SS Series has a uniquely designed flat bubble pH electrode design for reduced fouling potential. Reduce your maintenance and cost versus colorimetric chlorine measurement or conventional electrochemical sensors by utilizing Pyxis replaceable Electrode Head (EH-766-01) for this sensor allowing for years of reliable service. The ST-766SS Series may be calibrated in-situ after cleaning via DPD Free Chlorine, Total Chlorine, Bromine or Chlorine Dioxide wet chemistry test measurement of active sample.
- The Pyxis FR-306-PLUS is a magnetic coupling motorized brush flow assembly that provides an inline mechanical cleaning of the ST-766SS Series bare gold electrode enabling sensor accuracy in challenging industrial cooling and process waters. This unique device enhances the convective mass transport of the oxidizer analyte to the sensor surface eliminating the need for precision flow control commonly required for other amperometric sensors on the market. The FR-306-PLUS also provides supplemental deactivation protection of the bare gold electrode for long life, stability and accuracy. The brushing operation of the FR-306-PLUS is activated by the pre-mounted FS-100 ultrasonic flow meter included on the OxiPanel-PLATINUM Series analyzers. The FR-306-PLUS also contains a 'chemical detergent injection port' in the assembly housing allowing for the optional injection of cleaning agents at the brush head for extremely challenged industrial waters containing oils and grease. The FR-306-PLUS may be operated at a broad range of sample flow from 200 and 800mL per minute with an inlet pressure of 7.5 - 87 psi. The FR-306-PLUS outlet flow line may be diverted to atmospheric tank/sump within the process itself for reuse or to a lower pressure zone of the recirculating water network.
- The Pyxis FS-100 is a state-of-the-art ultrasonic flowmeter that operates on the principle of transit time difference with a measurement range of 0–3,000 mL/min and resolution of 1mL. The sensors advanced PCB design offers built-in temperature compensation to eliminate the effect of temperature with instantaneous, accumulated, and controlled water flow based on user setpoint within the sensor itself. The sample flow rate is controlled via PID logic from the flow sensor to the pre-mounted motor valve on the OxiPanel-PLATINUM analyzer.
- Each OxiPanel-PLATINUM is provided with one UC-80-PLUS display that powers the ST-766SS Series sensor, FR-306-PLUS, FS-100 and valve based on the user programmed flow setpoint and system operation. UC-80-PLUS touch screen display/data logger provides sensor calibration & diagnostic interface with 5x 4-20mA, RS-485 and TCP output with 2x110VAC relays, 1x24VDC relay and one analog PID control relay.
- The OxiPanel-PLATINUM contains the Pyxis 4G CloudLink™ and global SIM card as a comprehensive data gateway to cloud device for live mobile APP trend view, data download and reporting. Contact Pyxis for activation details.

3. Order Information

Order Information

P/N

OxiPanel-PLATINUM IK-766SS-FCL-BPT <i>(Auto Brushing Free Chlorine + pH Analyzer w/Flow & Auto Flush Control)</i>	48751
OxiPanel-PLATINUM IK-766SS-TCL-BPT <i>(Auto Brushing Total Chlorine + pH Analyzer w/Flow & Auto Flush Control)</i>	46990
OxiPanel-PLATINUM IK-766SS-CLO-BPT <i>(Auto Brushing Chlorine Dioxide + pH Analyzer w/Flow & Auto Flush Control)</i>	47939
OxiPanel-PLATINUM IK-766SS-Br-BPT <i>(Auto Brushing Bromine + pH Analyzer w/Flow & Auto Flush Control)</i>	48512
OxiPanel-PLATINUM IK-766SS-NCL-BPT <i>(Auto Brushing Monochloramine + pH Analyzer w/Flow & Auto Flush Control)</i>	46117
OxiPanel-PLATINUM IK-766SS-PAA-BPT <i>(Auto Brushing PAA + pH Analyzer w/Flow & Auto Flush Control)</i>	48150
OxiPanel-PLATINUM IK-766SS-DCL-BPT <i>(Auto Brushing Chlorine + Sulfite + pH Analyzer w/Flow & Auto Flush Control)</i>	40759
OxiPanel-PLATINUM IK-766SS-TFCL-BPT <i>(Auto Brushing F-T Chlorine + pH Analyzer w/Flow & Auto Flush Control)</i>	42270

Optional & Replacement Accessories Information

P/N

ST-766SS-FCL <i>(Inline Free Chlorine/pH/TEMP/Conductivity Sensor 316L Stainless Steel)</i>	51154
ST-766SS-CLO <i>(Inline Chlorine Dioxide/pH/TEMP/Conductivity Sensor 316L Stainless Steel)</i>	55821
ST-766SS-Br <i>(Inline Bromine /pH/TEMP/Conductivity Sensor 316L Stainless Steel)</i>	52743
ST-766SS-TCL <i>(Inline Total Chlorine/pH/TEMP/Conductivity Sensor 316L Stainless Steel)</i>	51379
ST-766SS-NCL <i>(Inline MomnoChloramine /pH/TEMP/Conductivity Sensor 316L Stainless Steel)</i>	54731
ST-766SS-PAA <i>(Inline PAA /pH/TEMP/Conductivity Sensor 316L Stainless Steel)</i>	54803
ST-766SS-TFCL <i>(Inline Free + Total Chlorine/pH/TEMP/Conductivity Sensor 316L Stainless Steel)</i>	55659
ST-766SS-DCL <i>(Inline Chlorine + Sulfite /pH/TEMP/Conductivity Sensor 316L Stainless Steel)</i>	57300
EH-766 <i>(Replacement Electrode Head for ST-766SS-Series Sensors)</i>	22093
EH-766-01 <i>(Replacement Electrode Head for ST-766SS-DCL / ST-766-TFCL / ST-766-PAA Sensors)</i>	22277
FR-306-PLUS <i>(Replacement FR-306-PLUS Auto-Brushing Flow Assembly Replacement)</i>	24236
FRP-306-01 <i>(Replacement Brush Assembly Kit for FR-306-PLUS)</i>	20802
FRP-300-03 <i>(Brush Extraction Tool)</i>	23504
FS-100 <i>(Replacement Ultrasonic Flowmeter with Display 0-3000mL/Minute)</i>	54200
Sample Flow Regulating Motorized Valve w/4-20mA Control <i>(Replacement)</i>	21972
Fresh Water Flush Valve - 3 Way <i>(Replacement)</i>	25408
Discharge Water Diversion Valve - 3 Way <i>(Replacement)</i>	27733
UC-80-PLUS Display + Data Logging Terminal <i>(Replacement)</i>	72875
Pyxis pH Combo Calibration Pack <i>(pH 4-7-10 Calibration Solution 3-Pack - 500mL ea.)</i>	57007
Pyxis ORP Calibration Standard <i>(200mV ORP Calibration Solution – 500mL)</i>	57020
Pyxis Conductivity Calibration Standard <i>(1,000uS/cm – 500mL)</i>	57008
Pyxis Zero Oxidizer Calibration Standard <i>(0ppm Oxidizer Solution – 500mL)</i>	21022
Pyxis Probe Cleaning Kit <i>(Probe Cleaning Solution, Brush, Q-tips & Jar – 500mL)</i>	SER-01

4. Analyzer Dimension and Mounting

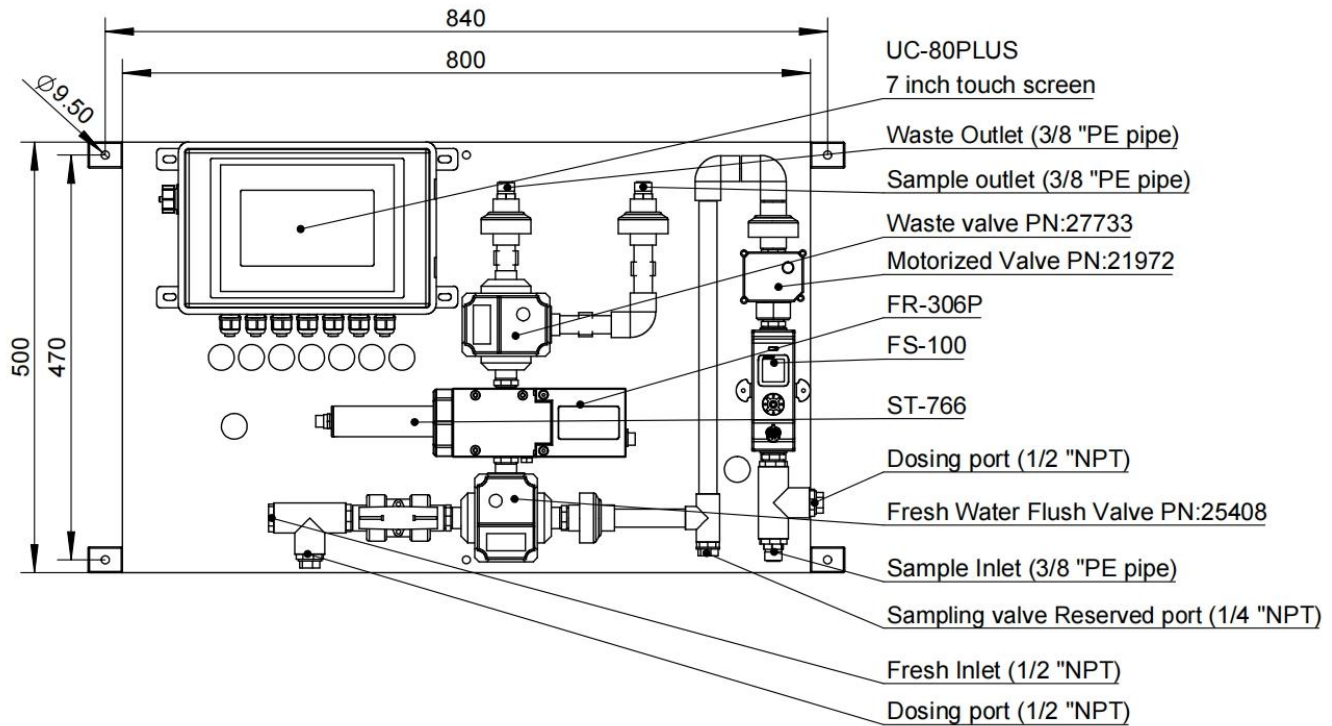

Figure. 1 - OxiPanel-PLATINUM IK-766SS-BPT Series

5. Analyzer Installation

5.1. Installation Requirements

Power Supply: 96-260VAC / 50-60 Hz; 60 W

Inlet Water Supply: The inlet water pressure should be from 7.25 – 87 psi (0.05-0.6MPa) with an inlet feedwater line diameter of 3/8-inch OD tubing adapter threaded into 1/2-inch FNPT socket.

***NOTE:** Users can program the desired inlet sample water flow on FS-100 screen interface as outlined. The recommended inlet sample water flow should be between 200-800ml/min. If the water is severely fouled, users can operate the OxiPanel PLATINUM at a higher flow rate as desired, as high as 3,000mL/minute, however may have to recalibrate the ST766 series sensor oxidizer once adjusted.

Outlet Water Line: The sample water outlet diameter is 3/8-inch OD tubing adapter threaded into 1/2-inch FNPT socket. This line should be returned to atmospheric sump or lower pressure recirculation line of the analyzed system water network.

Wall Mount Space: The OxiPanel-PLATINUM analyzer panel size is roughly 500H x 800W x 230D (mm) in dimension. Please leave at least 0.5m of installation space around the equipment for later maintenance.

Wall Mount Weight: Approximately 10kg. Please use appropriate mounting hardware.

5.2. Sample Water Connection

1. **Sample Water Inlet:** Connect the inlet water $\frac{3}{8}$ -inch OD tubing to the quick adapter provided.
2. **Sample Water Outlet:** Connect the outlet water $\frac{3}{8}$ -inch OD tubing to the quick adapter provided.
3. **Fresh Water Inlet:** Connect the Flush water $\frac{1}{2}$ -inch NPT external threaded joint to the $\frac{1}{2}$ -inch NPT internal thread port.
4. **Waste Water Outlet:** Connect the waste water $\frac{3}{8}$ -inch OD tubing to the quick adapter provided.
5. **Dosing port:** According to the requirements, the on-site dosing pump can be connected to either of these the $\frac{1}{2}$ -inch NPT internal thread dosing ports.

NOTE OD Tubing adapters are provided as a convenience. If desired, users may remove the $\frac{3}{8}$ -inch OD tubing adapter and directly plump the sample water inlet/outlet via $\frac{1}{2}$ -inch NPT piping to the OxiPanel-PLATINUM analyzer.

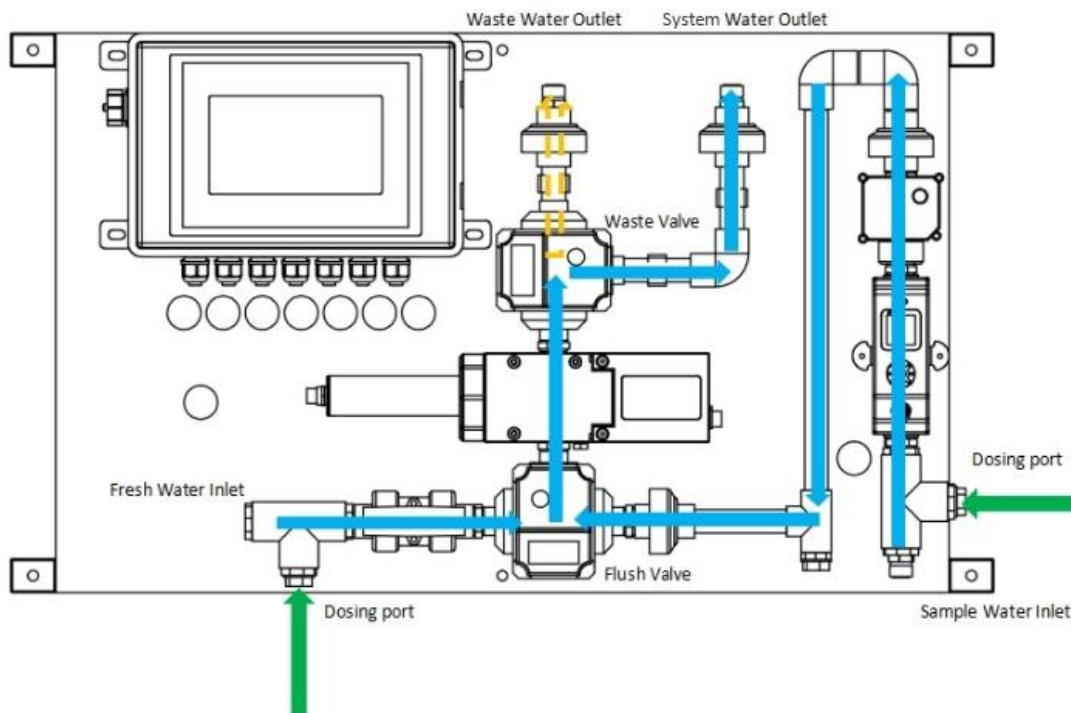

Figure. 2 OxiPanel PLATINUM Diagram Overview

5.3. Terminal Board Wiring

The OxiPanel-PLATINUM IK-766SS-BPT series has universal AC power supply equipment allowing users simply to plug the power supply into a 100~240V AC 50/60Hz power outlet for normal operation.

The controller circuit board has two 24VDC relay outputs.

- Relay #1 DC has been used for the control of the Flush valve
- Relay #2 DC can be used for on-site applications.
 - o When in ACTIVE mode, the relay is 24VDC powered.
 - o When in PASSIVE mode, the relay is a dry contact.

****IMPORTANT NOTE**** - The status of Relay #2 DC can be user adjusted to either ACTIVE or PASSIVE according to the on-site conditions.

****CRITICAL NOTE **** - Under NO CIRCUMSTANCES should the status of "Flush Valve" be altered.

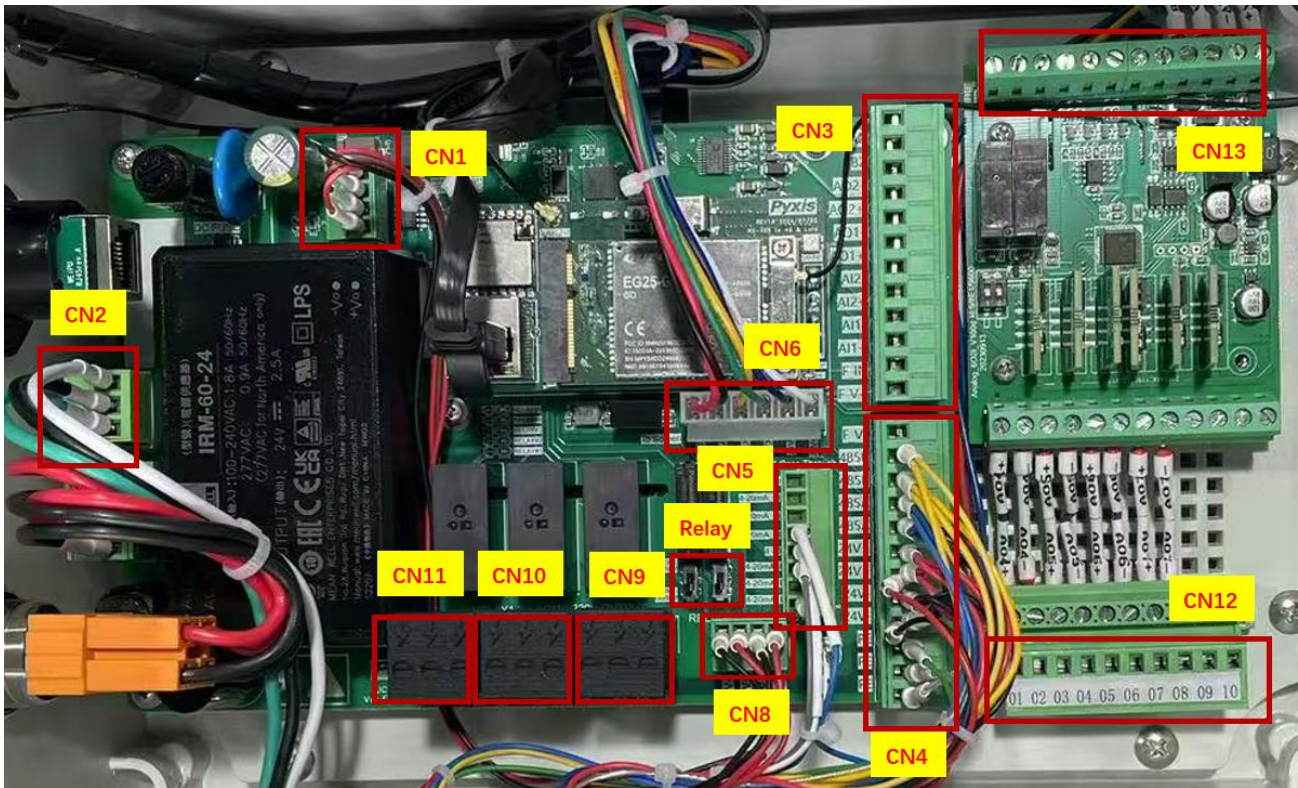
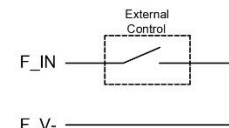
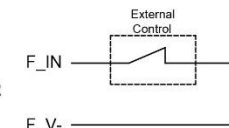

Figure. 3 – Terminal board of the UC-80-PLUS Display

Terminal Number	Definition	
CN1	0V	24V-(Waste Valve)
	V2	24V+(Waste Valve)
	0V	24V-(ST-766)
	V1	24V+(ST-766)
CN2	Terminal Number	Definition
	N	AC110~220V 50/60Hz : N
	L	AC110~220V 50/60Hz : L
	PE	PE
CN3	Terminal Number	Definition
	A2	DCS:485A
	B2	DCS:485B
	AO2-	4-20mA- DCS:AO2
	AO2+	4-20mA+ DCS:AO2
	AO1-	4-20mA- DCS:AO1
	AO1+	4-20mA+ DCS:AO1
	AI2-	4-20mA- Input:AI2
	AI2+	4-20mA+ Input:AI2
	AI1-	4-20mA- Input:AI1
	AI1+	4-20mA+ Input:AI1
	F_IN	DI
	F_V+	/
	CN4	Terminal Number
F_V-		DI_0V
485B		B(ST-766)(Brush)
485B		B(Flow)(AI Module)
485A		A(ST-766)(Brush)
485A		A(Flow)(AI Module)
24V+		24V+(Brush)(Flow)
24V+		24V+(Connector)(AI Module)
24V-		24V-(Brush)(Flow)
24V-		24V-(Connector)(AI Module)
PE		PE(ST-766)
PE		PE(Brush)
PE		PE(Flow)
CN5		Terminal Number
	4-20mA-	4-20mA- DCS:AO
	4-20mA Out#1	4-20mA+ DCS:Oxidizer
	4-20mA Out#2	/
	4-20mA Out#3	6(Connector)
	4-20mA-	4-20mA-(ST-766)
	4-20mA IN#1	4-20mA+(ST-766)
	4-20mA IN#2	/
	4-20mA IN#3	4-20mA+(Flow)
CN8	Terminal Number	Definition
	24V-	24V-(Flush Valve)
	24V+#1	24V+(Flush Valve)
	24V-	24V-(Relay#2 DC)
24V+#2	24V+(Relay#2 DC)	
CN9	Terminal Number	Definition
	AC_L#3	L(Relay#3 AC)
	AC_N#3	N(Relay#3 AC)
PE	/	

Terminal Number	Definition	
CN10	AC_L#2	L(Relay#2 AC)
	AC_N#2	N(Relay#2 AC)
	PE	/
CN11	Terminal Number	Definition
	AC_L#1	L(Detergent)
	AC_N#1	N(Detergent)
PE	/	
CN12	Terminal Number	Definition
	XT1	4-20mA+ DCS:Flow
	XT2	4-20mA- DCS:Flow
	XT3	/
	XT4	/
	XT5	4-20mA+ DCS:Conductivity
	XT6	4-20mA- DCS:Conductivity
	XT7	4-20mA+ :Control
	XT8	4-20mA- :Control
	XT9	/
XT10	/	
CN13	Terminal Number	Definition
	+24V	24V+(CN4)
	GND	24V-(CN4)
	485A	485A(CN4)
	485B	485B(CN4)
	AI1+	/
	AI1-	/
	AI2+	/
	AI2-	/
	Y0	/
COM	/	
Y1	/	
COM	/	

DI Signal

OR

Relay	Type	Analog Output Define	
		Define	Define
	IK-766SS-FCL-BPT	AO1	ORP
	IK-766SS-CLO-BPT	AO2	pH
	IK-766SS-Br-BPT		
	IK-766SS-TCL-BPT	AO3	FCL
	IK-766SS-PAA-BPT		
	IK-766SS-NCL-BPT		
IK-766SS-DCL-BPT	AO1	pH	
	AO2	Sulfite	
	AO3	FCL	
IK-766SS-TFCL-BPT	AO1	pH	
	AO2	FCL	
	AO3	TCL	

Figure. 4 - Terminal Wiring Diagram

6. Analyzer Components & Dimensions

6.1. UC-80-PLUS Display & Data Logging Terminal (mm)

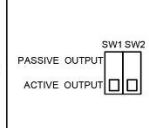
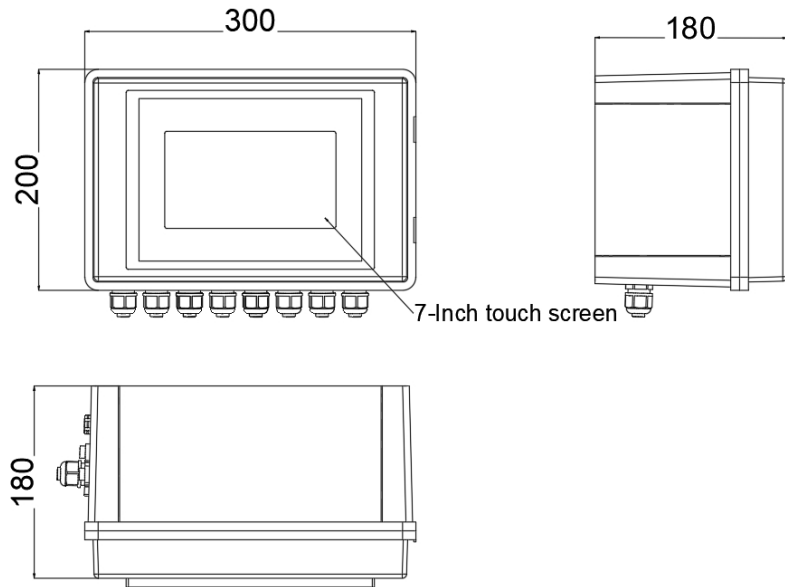

6.2. FS-100 Ultrasonic Flow Meter (mm)

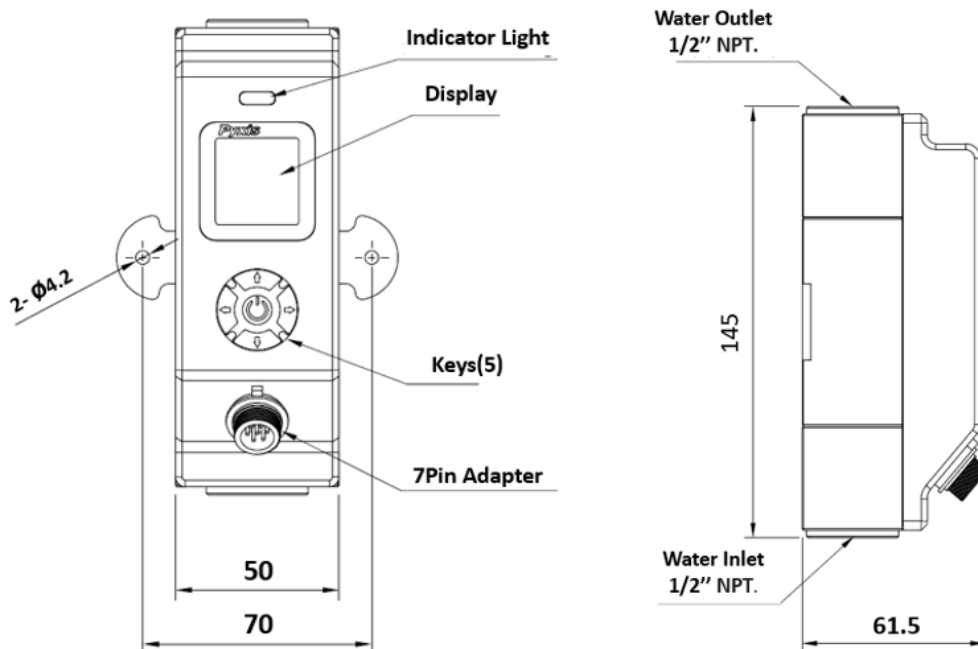

6.3. FR-306-PLUS Automatic Brushing Flow Assembly (mm)

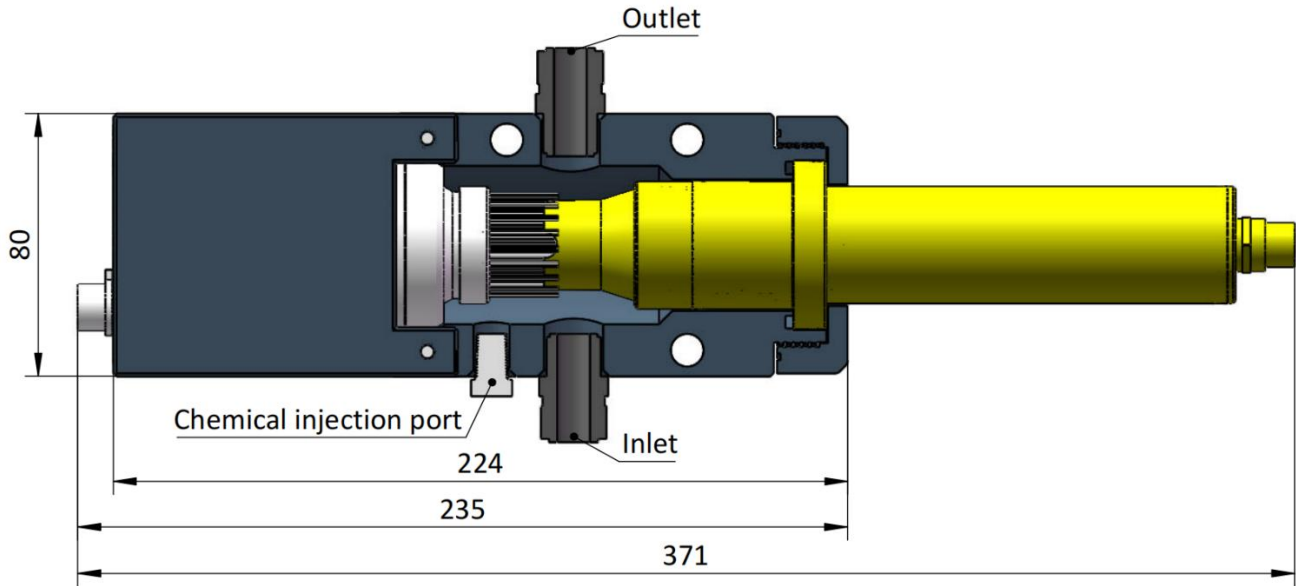

6.4. ST-766SS Series Sensor (mm)

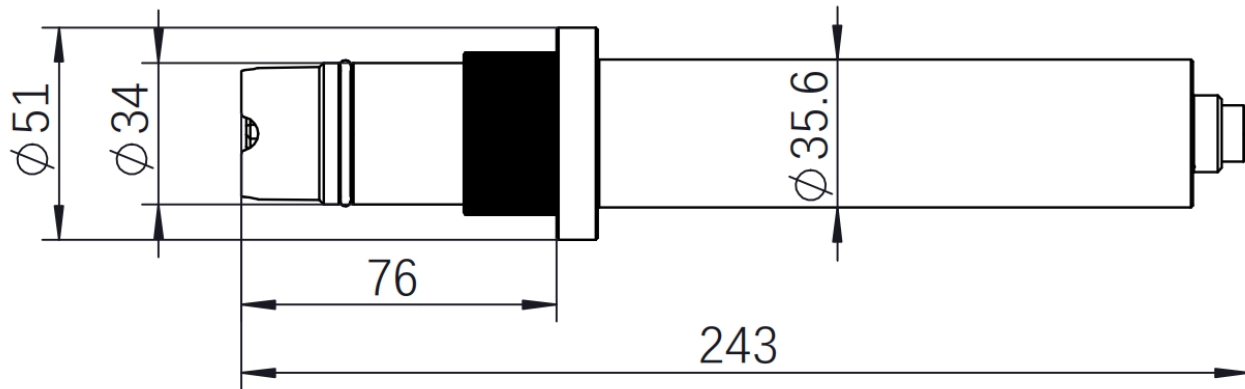

7. FS-100 Flow Control Module Overview & Use

The Flow Control Module is a stand-alone water flow measurement and control solution, a unique platform that provides accurate flow measurement and regulation. The Flow Control Module is equipped with the Pyxis FS-100 ultrasonic flow meter with display, which allows direct control of pre-installed regulating valves through a simple user programmable interface and a measurement range of 0 – 3,000mL/min.

Enter Key

- Main screen → Setting Menu.
- Confirms and saves the input values.

Left / Right Key

- Main screen → Trend Chart.
- Move the cursor to the left or right.
- Turn pages on the screen.

Up / Down Key

- To increase or decrease a displayed number value.
- Jump up and down in the operating menu.

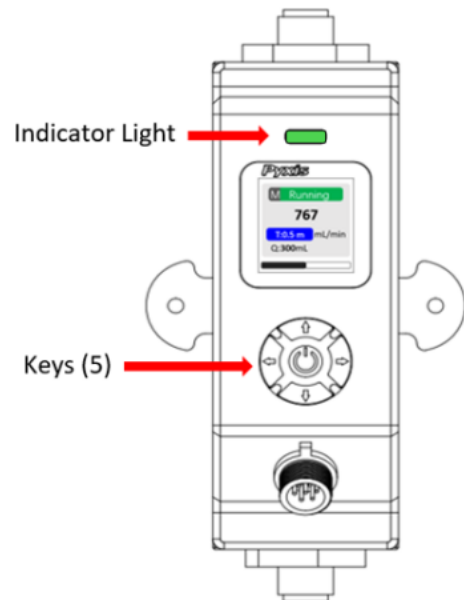

7.1. FS-100 Key Function

LED Status Indicator

The status LED is used for a quick visualization of the flowmeter status.

LED Behavior	Status
Green	Normal Running
Red	Alarm Information

7.2. FS-100 Main Screen

Main Screen Description

NO.	Description
1	Flow Detection Mode ⁽¹⁾
2	Working Status (same color as LED status indicator)
3	Flow Rate Value
4	Timer ⁽²⁾ (unit: auto range)
5	Unit of measured flow value
6	Accumulated Flow Value (unit: auto range)

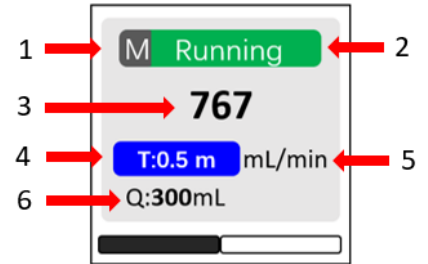

(1) R = Average Flow Rate Mode

M = Instantaneous Flow Rate Mode

C = Flow Rate Control Mode ***NOTE*** For C-Mode refer to Section 7.4 for programming details.

(2) The **Timer** feature is enabled when the FS-100 is powered on and can be set by pressing the ▼ key.

- **Pause or Restart the Timer:** Press ▼ key momentarily and release.
- **Reset the Timer:** Press and hold ▼ key for about two seconds

7.3. FS-100 Flow Trend Chart

From the main screen, Press ◀ or ▶ to the trend chart display. Flow values will be displayed as a line graph to show the real-time trend. Press ◀ or ▶ to return to the main screen.

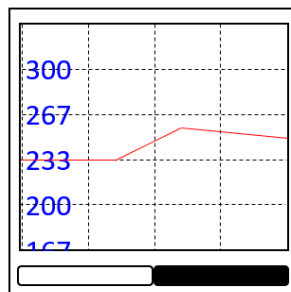

Figure. 5 - FS-100 Flow Trend Chart

7.4. FS-100 - Setting the C-Mode for the Sample Flow Control

The Oxipanel PLATINUM series are programmed to use the Flow Rate Control (C) mode by default, which does not need to be changed by the customer. If a change to measure only is desired (with no control) users may follow the steps below to adjust the FS-100 functional settings.

Press ◀ or ▶ in the setting menu and select *[Pattern]*. The following operating modes are available:

- Flow Rate (R) = Display the average flow rate
- Flow Meter (M) = Display the instantaneous flow rate
- Flow Control (C) = Set a desired constant flow rate

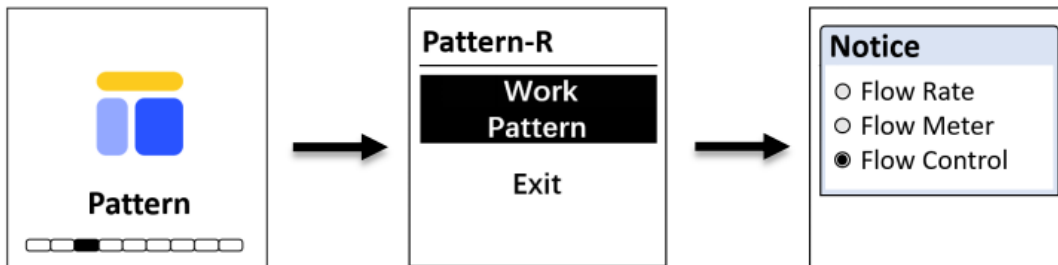

Figure. 6 - Operating Mode

When Flow Control Mode (C) is selected, a user defined flow rate setpoint must be entered (Figures 6 & 7). The FS-100 will automatically control the regulating valve according to the preset flow rate with an internally calculated PID algorithm.

NOTE The Oxipanel PLATINUM Series should be operated within the recommended flow rates of 200-800 mL/min. If the water is severely fouled, users can operated the OxiPanel PLATINUM at a higher flow rate as desired, as high as 3,000mL/minute, however may have to recalibrate the ST766 series sensor oxidizer once adjusted.

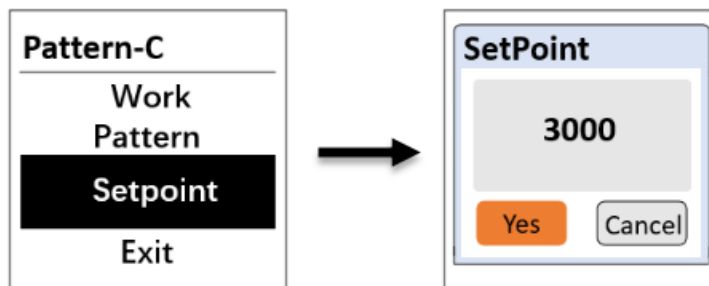

Figure. 7 - Flow Control (C) Operating Mode with User Defined Setpoint

NOTE If the actual flow rate does not reach the preset flow rate for a duration time of longer than two minutes, the main screen and LED indicator will display **RED** alarm status.

7.5. FS-100 Modbus Communication Settings

Press ◀ or ▶ in the setting menu and select **[Com]** to modify communication parameters (Figure 7). The following communication settings are pre-programmed into the FS-100 for direct communication with the OxiPanel PLATINUM display interface. ****IMPORTANT NOTE**** *These values should NOT BE ALTERED, otherwise flow control failure will occur.*

- Modbus Address = 95
- Baud Rate = 9600
- Parity = Even

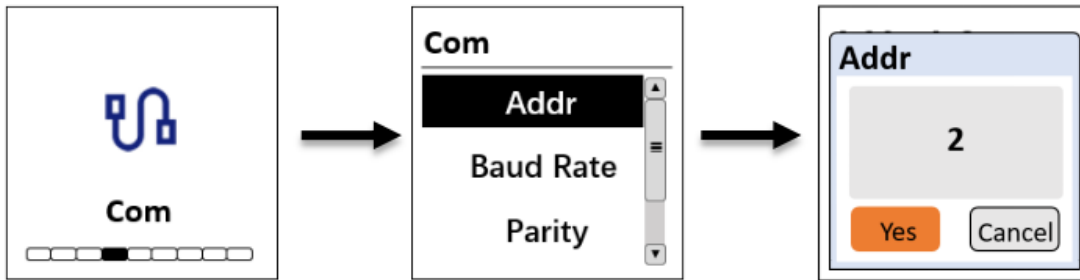

Figure. 8 - Communication Settings

7.6. FS-100 Factory Reset

If the user wants to restore all device settings to factory default parameters, Navigate to **[Info]** screen (Figure 10), press and hold ⏻ key for about two seconds, the FS-100 will reboot itself (Figure 9).

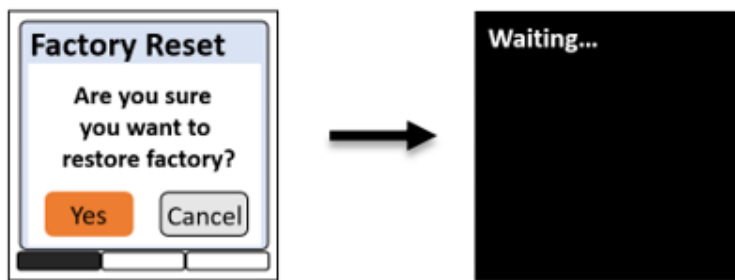

Figure. 9 - Factory Reset

7.7. FS-100 Device Information & Diagnosis

Press ◀ or ▶ in the setting menu and select *[Info]*. This screen contains the device name, serial number, software version, and hardware version. Provide an image of both the **DEVICE INFORMATION** screen and the **DIAGNOSIS** screen when you contact Pyxis (service@pyxis-lab.com) for troubleshooting your device or call +1 (866) 203-8397 ext 2.

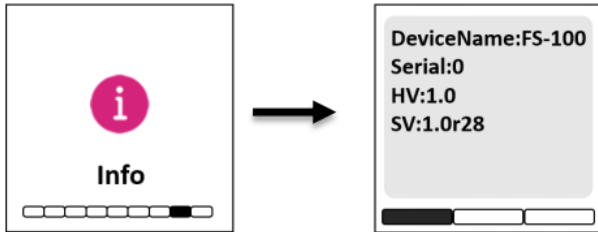

Figure. 10 - Device Information

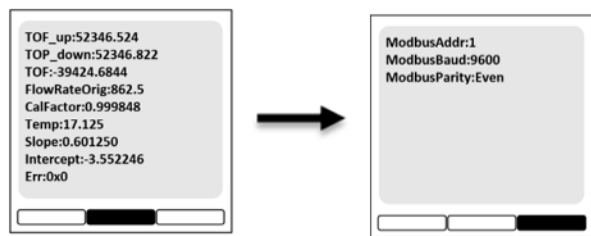

Figure. 11 - Diagnosis

Press ◀ or ▶ to turn the page. This screen information has no use for normal operation, but instead is used for device troubleshooting. Provide an image of both the **DEVICE INFORMATION** screen and the **DIAGNOSIS** screen when you contact Pyxis (service@pyxis-lab.com) for troubleshooting your device or call +1 (866) 203-8397 ext 2.

8. UC-80-PLUS Display Touch Screen Operation

8.1. Main Screen

After the system is powered on an initial screen allows the user to log into the system.

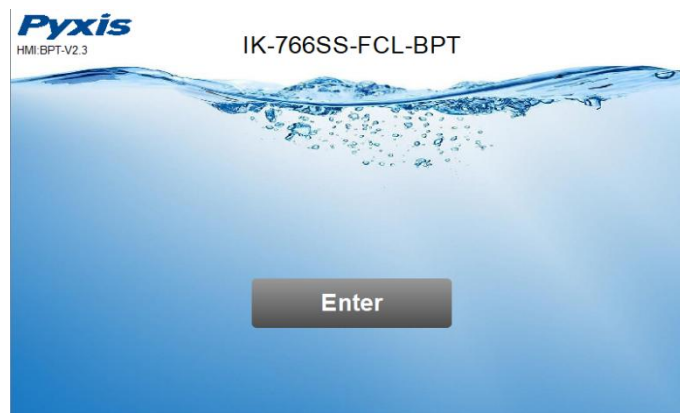

Figure. 12 - Main Screen

8.2. User Login & Password

After powering on the system, log in with the user name and password to be able to change system settings. Click the "User Login" button, select the user "pyxis", enter the password: "888888" in the user password field. A new user can be added via "User Management" in interface of the menu.

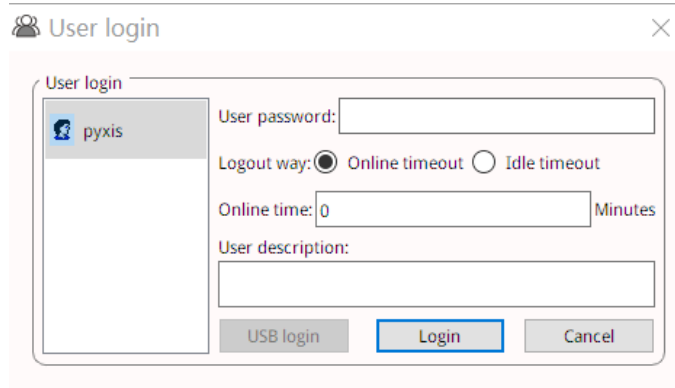

Figure. 13 - User Login Screen

If you do not need a password, or want to change the user, you can enter the system and manage in the "User Management" screen of the menu

8.3. Real-Time Monitoring

Click the "Enter System" button on the main interface to enter the real-time monitoring screen of the system. The data detected by the Pyxis sensors will be displayed in real-time.

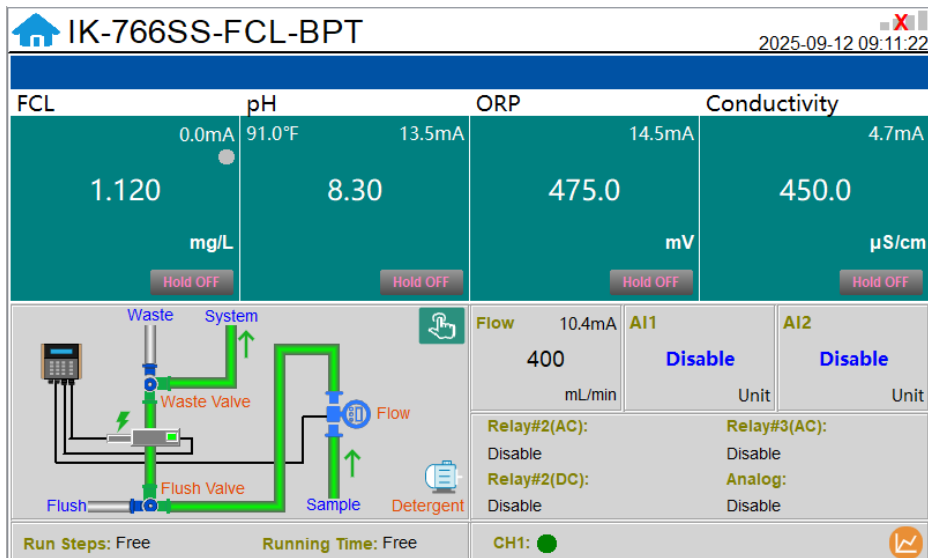

Figure. 14 - Real-time monitoring screen

Click on the time in the upper right corner, the screen pops up the time setting window.

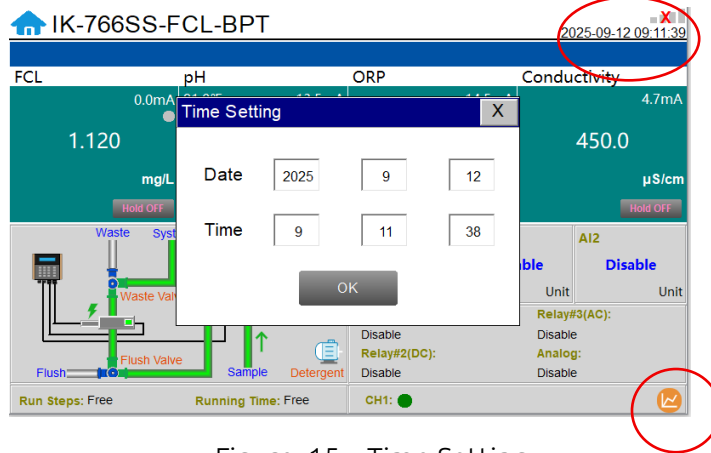

Figure. 15 - Time Setting

Click the orange tilde icon located in the lower-right corner to access the real-time curve interface.

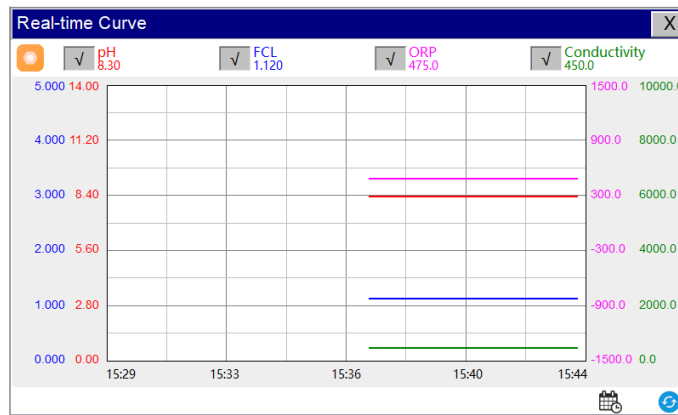

Figure. 16 - Real-time Curve

Click the refresh icon in the bottom-right corner, the icon turns blue and the real-time curve stops refreshing. Click again to restore it. By clicking the calendar icon in the bottom-right corner, users can set the parameters of the X-axis.

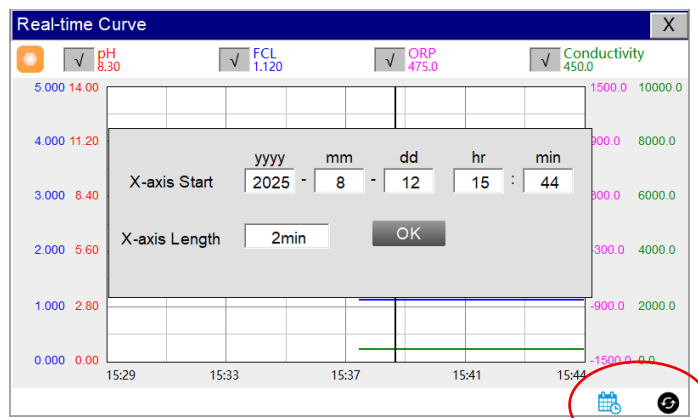

Figure. 17 - X-axis Range

By clicking the orange icon in the top-left corner, the user can set the parameters of the Y-axis.

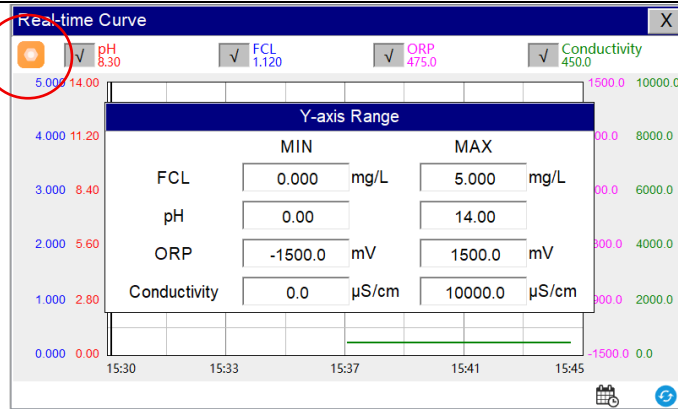

Figure. 18 - Y-axis Range

Click the gesture button at the top right of the flowchart, and the interface will enter the control window.

NOTE - When the system is in cleaning mode the real-time sensor values will be locked.

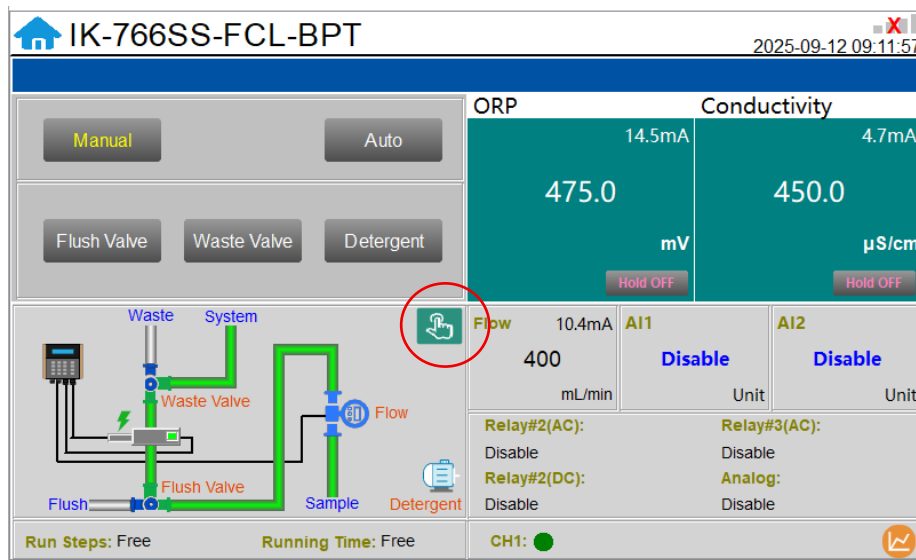

Figure. 19 - Control Interface

When placed in **Manual Mode**, Users can control Flush Valve, Waste Valve and the detergent dosing pump by clicking the corresponding buttons.

NOTE - Once the Manual Interface is initiated, the start and stop of the dosing pump will be based on the settings in this interface and override the automatic programming. i.e. Even if the Sample Water Detergent setting (see section Cleaning Control) is checked in the cleaning control interface, detergent feed dosing pump remains in the state according to the status of this interface.

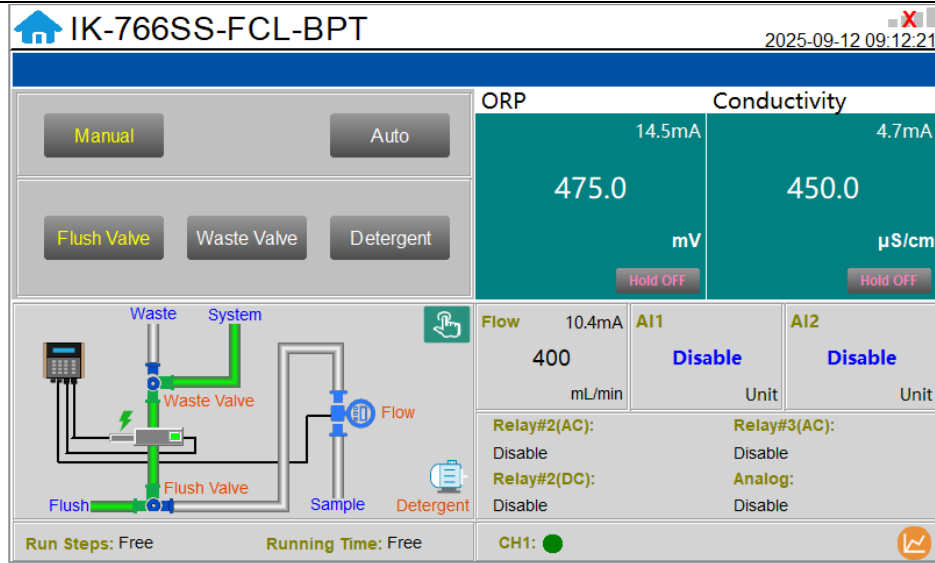

Figure. 20 - Control Interface_2

When placed in **Automatic Mode**, the pipeline system will operate according to the parameters set in the **Cleaning Control Interface** (see section 8.6.1).

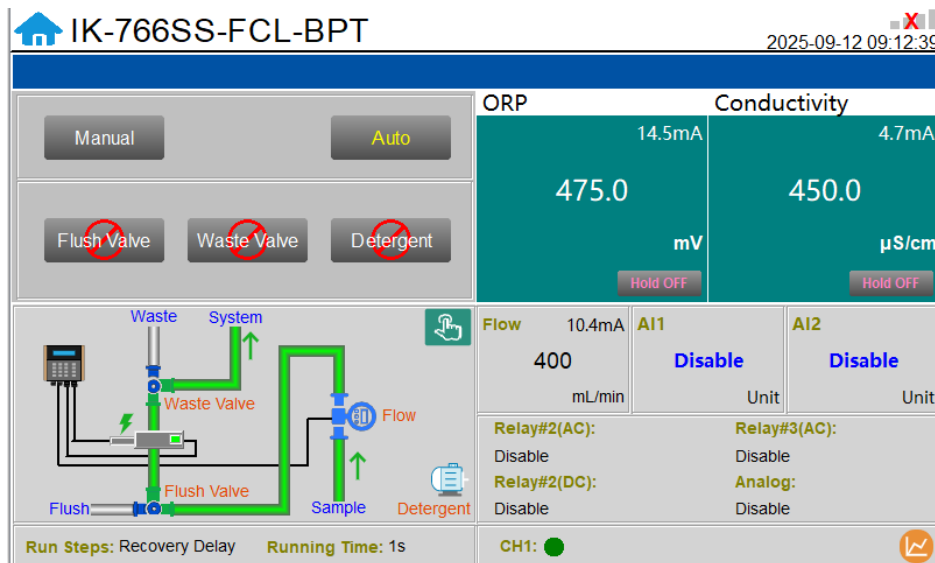

Figure. 21 - Control Interface_3

8.4. Explanation and use of the Output Signal HOLD Feature

The OxiPanel PLATINUM has an integrated **HOLD** feature for all output parameters from the sensor that would be connected to an onsite DCS network. The purpose for this feature is to allow the user to enter a signal value HOLD on the designated parameter during periods of sensor maintenance or removal. This feature prevents network system alarms from operational shutdown during sensor maintenance or replacement.

Click the **"Hold OFF"** button on the main interface to enter the HOLD setting interface.

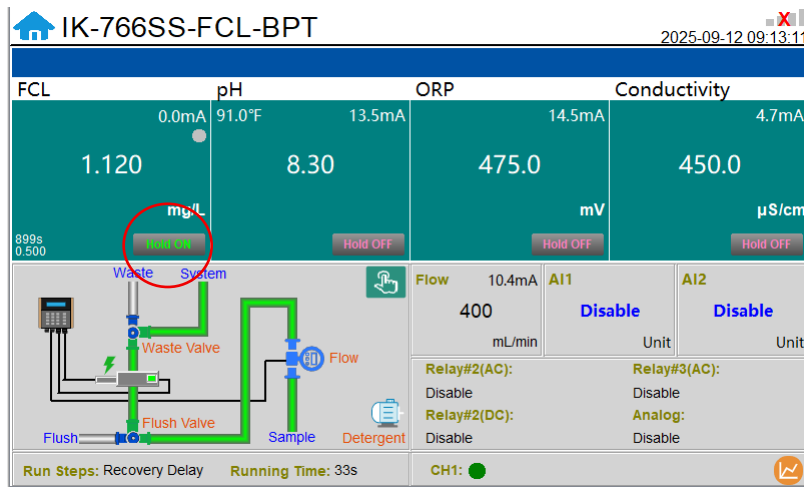

Figure. 22 - Main Interface

In **"SetValue"** users can enter the parameter value to be held, clicking on **"Confirm"** will turn the **"Hold ON"** function on, at this point the unit's 4-20mA, RS-485 Modbus-RTU and Modbus-TCP will continue to hold the value entered by the user, ensuring that network alarms and processes are not interrupted by the sudden change of the "actual" value. During this time, the main screen will display the sensor's "actual" real-time measured value, and the user-entered hold value reading will be displayed in the lower left corner of that measured value box.

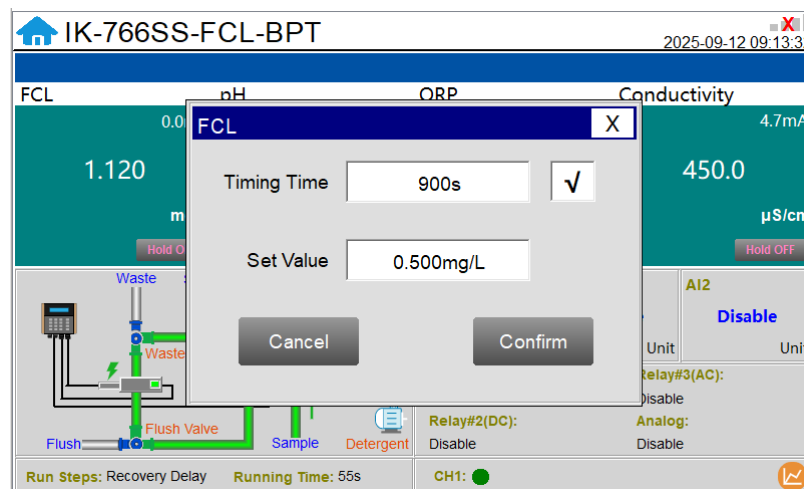

Figure. 23 - Hold Feature

If the "Hold ON" function needs to be turned off, click on the "Hold ON" button to return to the setup screen, and click on "Cancel" and the main screen will immediately display the real-time value read by the sensor, and the main screen button will be displayed as "Hold OFF".

In the setting interface, you can select "Timing Time" to enable the auto time out function and set the required duration. When the Hold value is set, a countdown will be performed. When the countdown ends, the "Hold ON" will be automatically changed back to "Hold OFF". The countdown timer is also displayed in the lower left corner of the measured value box.

8.5. Menu Bar

Click the button in the upper left corner of the screen to enter the system's menu interface, where the user can select to enter the desired operation interface.

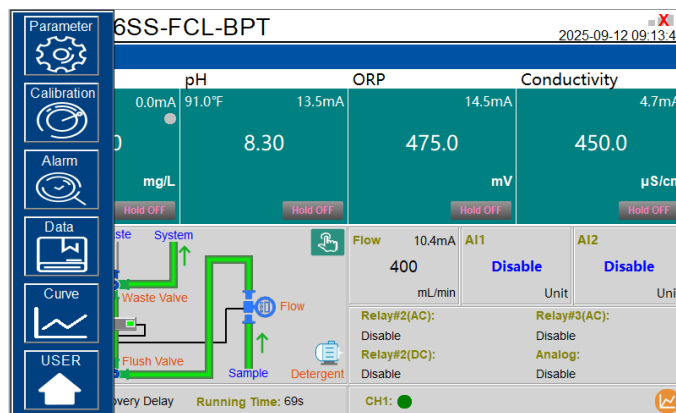

Figure. 24 - Menu Bar

8.6. Configurable Parameters

Click the "Parameter" button in the menu bar. Here you can select a list of options to include enter Control Interface /Settings Interface /User Defined Settings / Information Service/ 4-20mA Input and DCS Output.

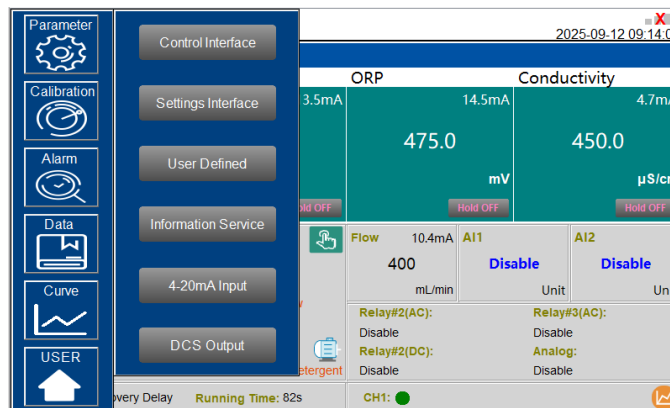

Figure. 25 - Parameter Settings Menu

8.6.1. Control Interface

Clicking on "Control Interface" opens a sub-menu for Flow Interlock Control, Output Control, Output Limiting and Cleaning Control.

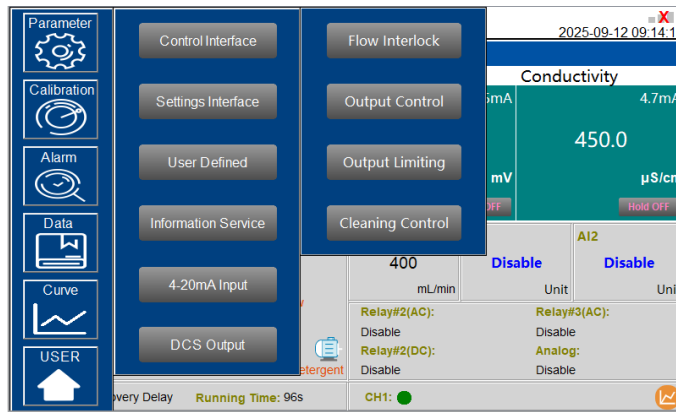

Figure. 26 - Control Interface

Flow Interlock Control

When placed in **Manual Mode**, users can independently power ON and OFF both the FR-306-PLUS brushing assembly and ST-766SS Series sensor as desired.

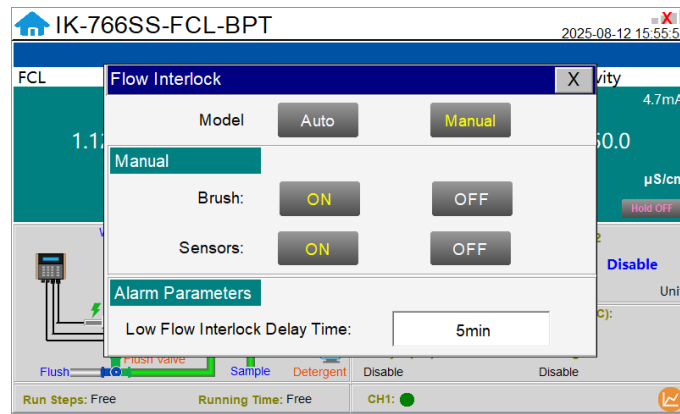

Figure. 27 – Flow Interlock Control – Auto & Manual Mode

When in **Automatic Mode** both the FR-306-PLUS brush motor and ST-766SS Series sensor will be interlocked with the FS-100 inline ultrasonic flow meter and will only remain powered ON simultaneously if the sample water flow rate is greater than 200ml/min.

When the sample water flow is less than 50ml/min, the FR-306-PLUS brush motor and ST-766SS Series sensor will be powered OFF and the main interface will display "----"; until the sample water flow returns to >200ml/min at which time the brush will start immediately, and the sensor will display a live reading after a 5min electrode initialization period. The flow interlock delay (judgement time) default is 5-minutes, however this may be user adjusted.

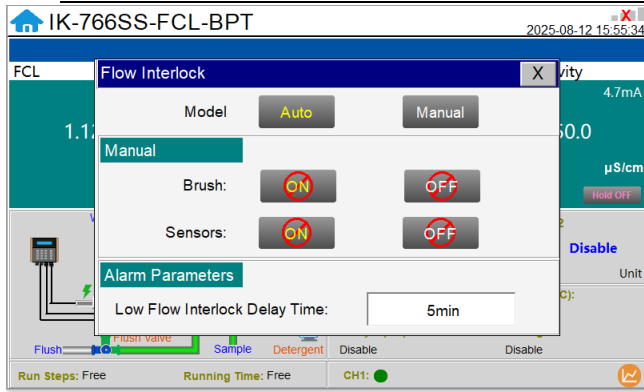

Figure. 28 - Flow Interlock Control - Auto Mode

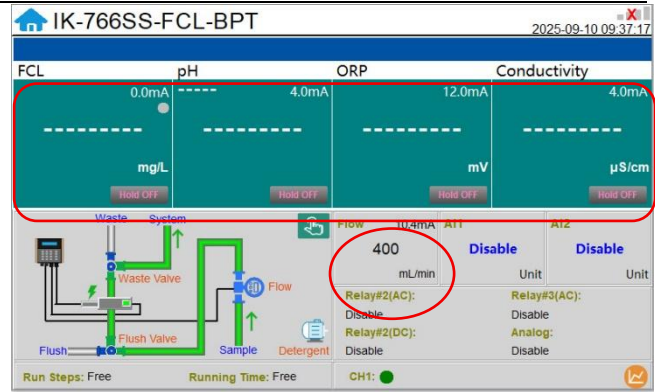

Figure. 29 - Numeric Display "---" Flow <50mL/min

NOTE In the event of a sudden power loss, the *Flow Interlock Control* mode will return to the same settings that were programmed before the power failure.

Output Control

The OxiPanel has (1) AC relay (#1) is prewired for detergent feed and (2) AC relays (#2 and #3) are usable relay outputs. One (1) usable 24VDC relay (#2 DC) output and one (1) Analog Output that can be used in the field. When the equipment is delivered, the connection lines for the RELAY will already be pre-connected. On-site, you only need to connect the cables according to the labels on the cables to the corresponding on-site equipment.

Relay Outputs

Both AC Relay outputs and DC Relay output all have 4 modes of operation including **Disable/Manual/Periodicity** and **Sensor Value**

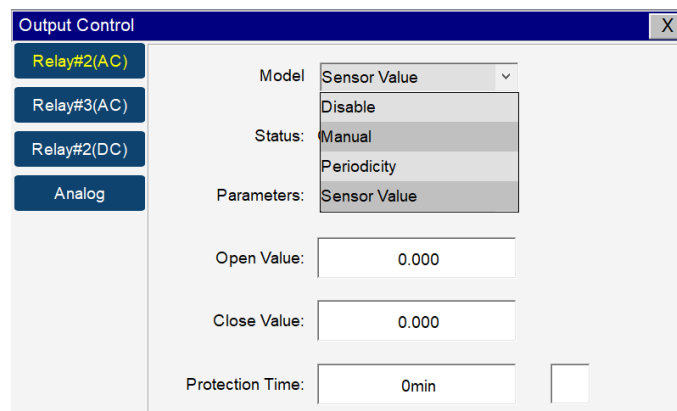

Figure. 30 – AC Relay Output Control

When the mode selection is set to **Disable**, there will be no relay output available.

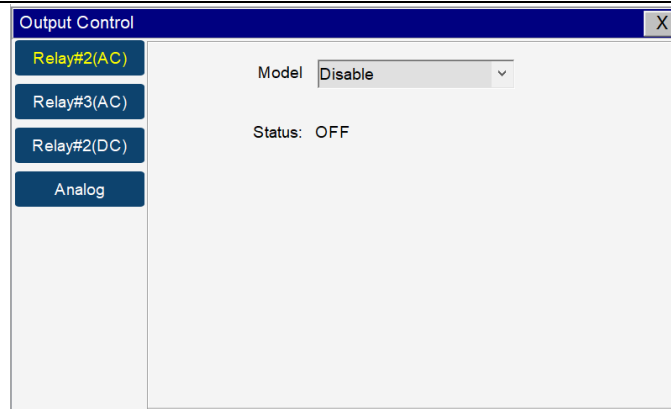

Figure. 31 – Disable

When the mode is selected as **Manual**, users can manually turn on the Output by clicking the "Turn On" button in the lower right corner and turn it off by clicking the "Turn On" button again.

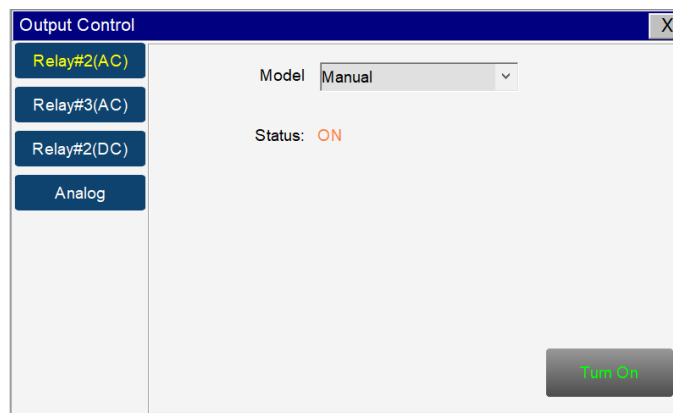

Figure. 32 – Manual

When the mode selection is **Periodicity**, it will periodically output according to the user programmed Interval Time and Running Time.

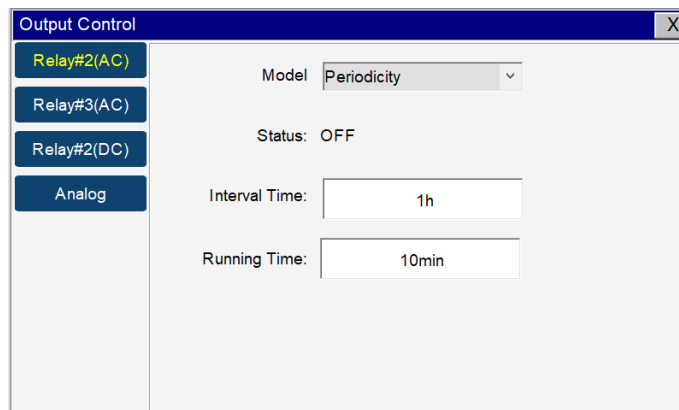

Figure. 33 – Periodicity

When the mode selection is **Sensor Value**, users can select which parameters they desire to control. See examples below.

Example 1: Open (ON) Value = 0.2
Close (OFF) Value = 0.5
Measured Value \leq 0.2 will Open the Relay
Measured Value \geq 0.5 will Close the Relay

Example 2: Open (ON) Value = 0.5
Close (OFF) Value = 0.2
Measured Value \leq 0.2 will Close the Relay
Measured Value \geq 0.5 will Open the Relay

Users can utilize the **Protection Time** to prevent over activation of the relay if the responding parameter does not come within desired range within a specified time. After relay opening, when the measured value continues to exceed the set shutdown value beyond the protection time, the relay will automatically shut down the output. This feature allows for overfeed prevention.

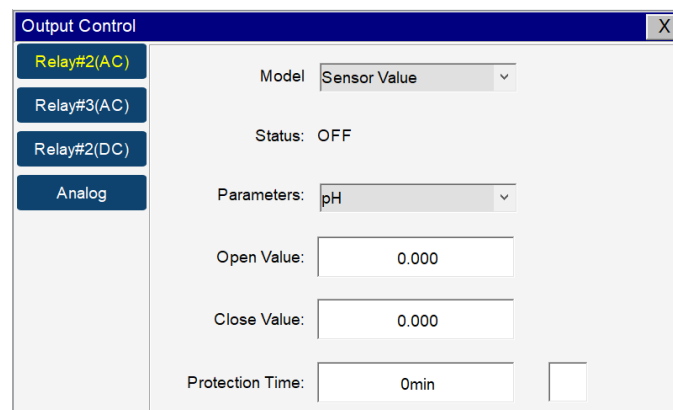

Figure. 34 –Sensor Value

The controller circuit board has two 24VDC relay outputs.

- **Relay #1 DC** has been used for the control of the Flush valve
- **Relay #2 DC** can be used for on-site applications.
 - o When in ACTIVE mode, the relay is 24VDC powered.
 - o When in PASSIVE mode, the relay is a dry contact.

****IMPORTANT NOTE**** - *The status of Relay #2 can be user adjusted to either ACTIVE or PASSIVE according to the on-site conditions.*

****CRITICAL NOTE **** - *Under NO CIRCUMSTANCES should the status of "Flush Valve" be altered.*

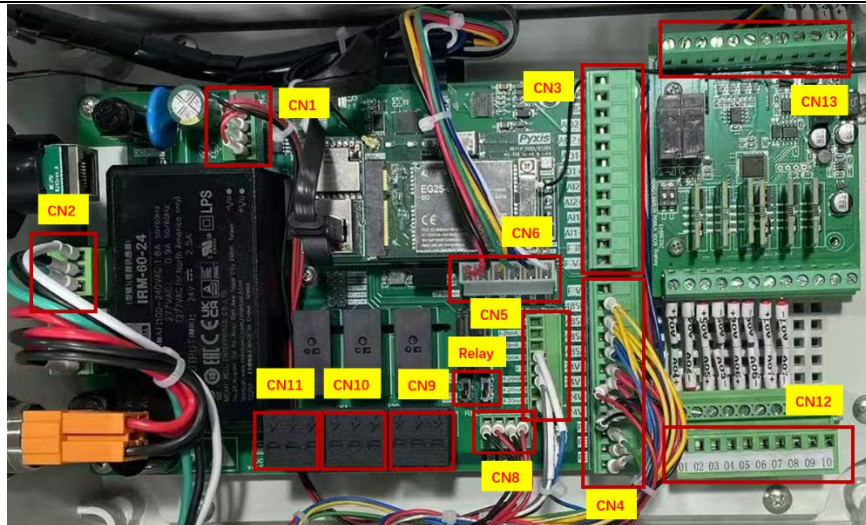

Figure. 35 – Relay Active/Passive Toggle Switch on UC-80-PLUS Terminal Board

The functions of DC relay and AC relay are the same. You can refer to the previous description of AC relay for details.

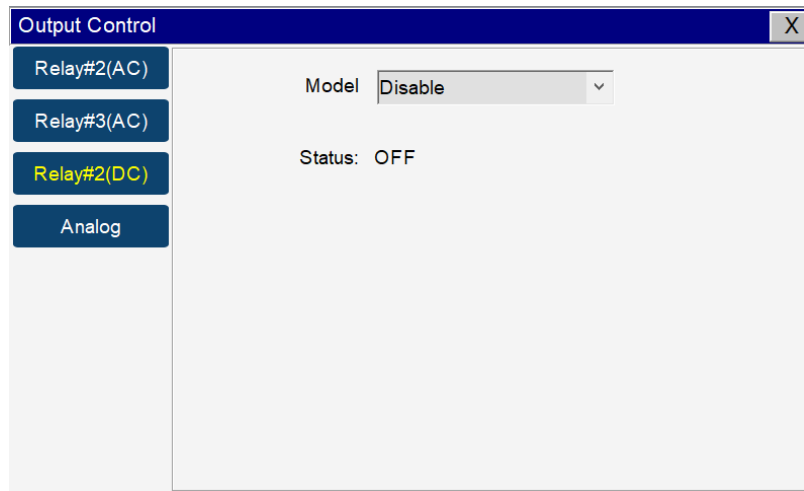

Figure. 36 – DC Relay Output Control

Analog Output for PID Control

The analyzer also offers one **Analog** output for 4-20mA control based on user setpoint. This feature has three control modes, **Disable**, **Manual** and **PID**.

When the mode selection is set to **Disable**, there will be no relay output available.

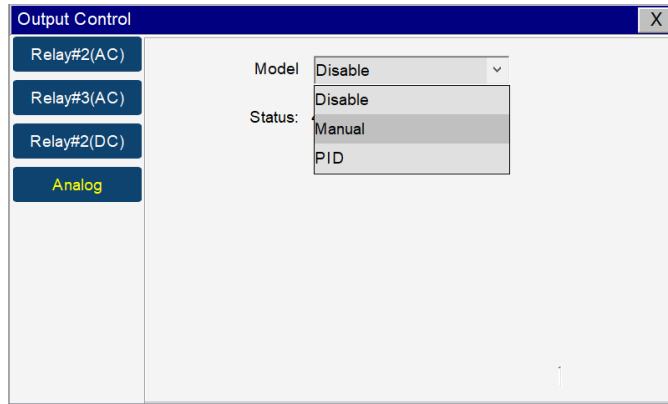

Figure. 37 –Analog Output

When the mode is selected as **Manual**, users can manually set the output value and turn on the Output by clicking the "Turn On" button in the lower right corner and turn it off by clicking the "Turn On" button again.

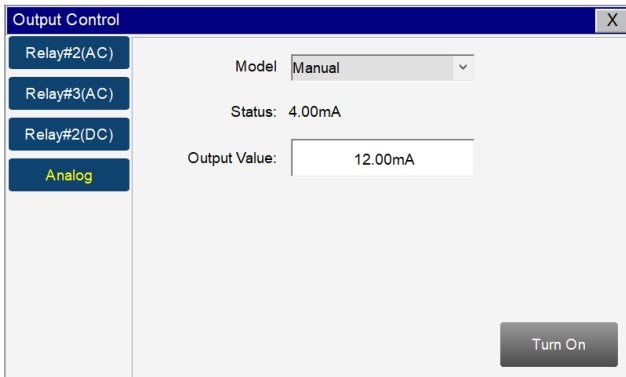

Figure. 38 –Analog Output Manual_Turn off

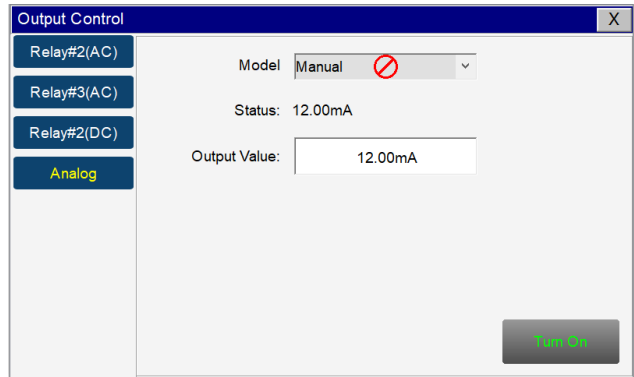

Figure. 39 –Analog Output Manual_Turn on

PID Control Explained

PID control, or Proportional-Integral-Derivative control, is a widely used feedback control technique in systems that require precise and stable control automation processes. It continuously calculates an error value as the difference between a desired setpoint and a measured process variable, adjusting control inputs to minimize this error over time. The PID controller consists of three components: **Proportional**, **Integral**, and **Derivative**.

Proportional (P) Control

The proportional term produces an output proportional to the current error. The larger the error, the stronger the response. It has a tuning parameter called the proportional gain (P), which adjusts how aggressively the system reacts to the error. However, proportional control alone may not eliminate steady-state errors and may cause oscillations if the gain is too high.

Integral (I) Control

The integral term accounts for the accumulated error over time, which helps to eliminate steady-state errors that the proportional control cannot resolve alone. The integral term adds up the error over time and adjusts the control signal to bring the system closer to the target value. It has a tuning parameter, the integral gain (I).

Derivative (D) Control

The derivative term predicts future error based on its rate of change. By reacting to the speed at which the error is changing, derivative control can dampen system oscillations and improve stability. However, it is sensitive to noise in the system, as it amplifies rapid changes. It has a tuning parameter, the derivative gain (D).

PID Control Equation

The combined PID control output is a weighted sum of the three components:

- **Proportional (P)** helps to reduce the error.
- **Integral (I)** helps to eliminate steady-state error.
- **Derivative (D)** helps to predict and counteract rapid changes, improving stability.

When selecting PID mode, you can select pH / Conc (Oxidizer) / ORP / Conductivity under parameters.

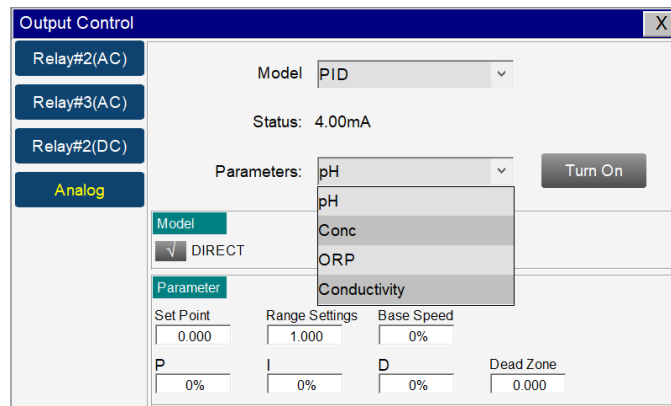

Figure. 40 –Analog Output PID

You can select control parameters in PID Control and set them separately.

Setpoint: Users Desired Setpoint

Range Settings: Desired Deviation from Setpoint for Max Response

Base Speed: Minimum output current (if the PID calculated current is lower than the Base Speed, output according to the Base Speed). For example, if the Base Speed is set to 10%, the actual minimum output current will be calculated as follows:
 $-(20\text{mA} - 4\text{mA}) * 10\% + 4\text{mA} = 5.6\text{mA}$

Dead Zone: Also known as inactive range. For example, if the Dead Zone is Set to 2 and the Set point is set to 10, the actual measured value is 8 to 12 (10-2 to 10+2), and the PID calculated current will be 4mA.

NOTE If the current corresponding to the Base Speed is greater than the calculated output current of the PID, the output is actually performed based on the current corresponding to the Base Speed; otherwise, the output is performed based on the calculated output current of the PID

Proportional (P) Adjustable Range: 0 ~ 100 (%)

Integral (I) Adjustable Range: 0 ~ 300 (%)

Derivative (D) Adjustable Range: 0 ~ 300 (%)

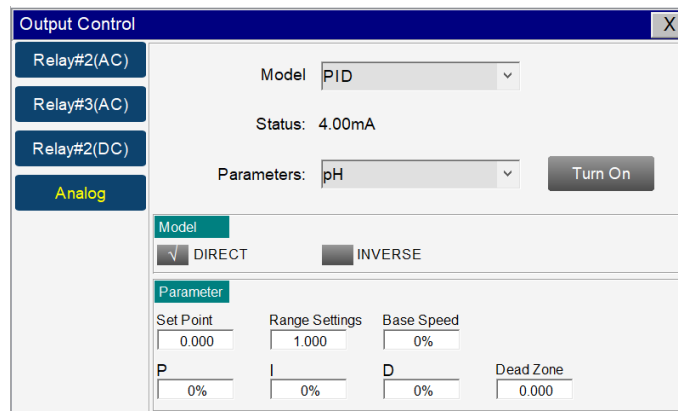

Figure. 41 –Analog Output PID

Explaining PID Programming

When adjusting the three main parameters of KP, KI and KD, please adjust the KP value (according to the experience value), set the KI and KD values to 0 at first, and then gradually adjust the KI value (from small to large) and KD value (from small to large) to achieve the condition of roughly controllable adjustment.

In PID, you can choose the setpoint operation mode to "DIRECT" or "INVERSE". Suppose Set point is set to 10, Range settings to 3, P to 100%, I to 0, D to 0, and Base Speed to 0%. When the mode is "DIRECT", If the real time value is less than or equal to 7 (Set Point - Range Settings), then 20mA is displayed. If the real time value is equal to Set point, 4mA is displayed.

When the pattern is "INVERSE" if the real-time value is greater than or equal to 13 (Set Point + Range Settings), then the output will show 20mA displayed. If the real-time value is equal to Set point, then output will show 4mA displayed.

If the DEAD ZONE is Set to 2, the output is 4mA if the real time value is 8-12 (Set point±2).

IMPORTANT NOTE After setting the above parameters, click "Turn On" to run according to the parameters, and all parameters cannot be changed at this time.

Output Limiting

DI (digital input) protection for both Relay or Analog outputs will protect the selected channel in the event of an electric disruption or anomaly. When turned ON, if the digital input signal turns OFF and continues beyond the JUDGING TIME, protection will be generated and vice versa.

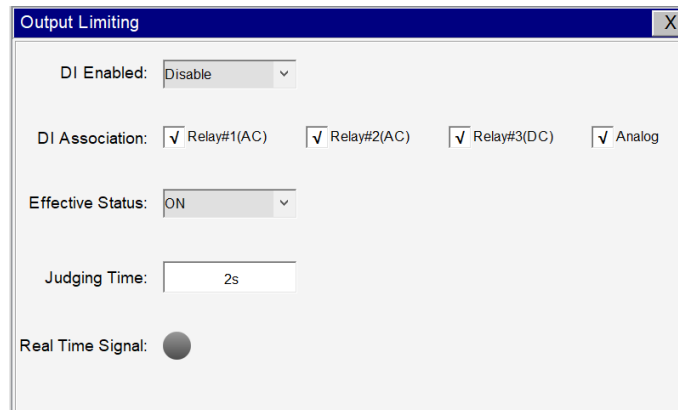

Figure. 42 – Output Limiting

Cleaning Control

Cleaning control interface, you can choose **Automatic** or **Manual** cleaning.

a) Automatic Mode

In automatic mode, the equipment will perform cleaning periodically according to the user programmed parameters.

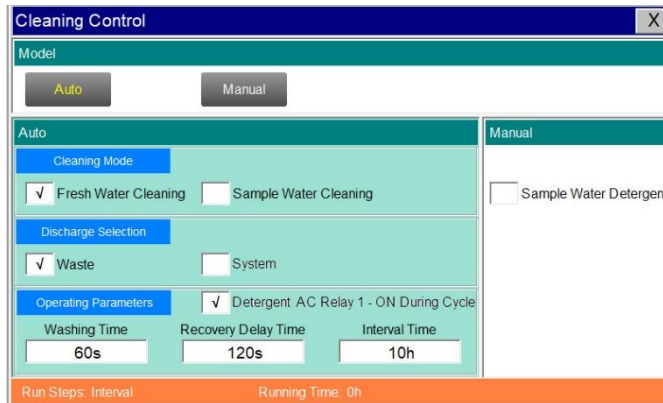

Figure. 43 – Automatic Cleaning Mode

Fresh Water Cleaning Cycle

In automatic mode, select "**Fresh Water Cleaning**" as the cleaning mode. During this cleaning process, the fresh water flush valve will be opened to allow fresh water flow following the direction as shown in Figure 44. During this cycle, users can choose to discharge the water to Waste or return the flow to Sample based on the specific application needs. If the user would like to feed a detergent during the fresh water cleaning stage, please connect the detergent dosing pump to the (Detergent AC Relay 1 plug pigtail) and the chemical pump discharge to the green arrow indicated in the Figure 44 diagram and select the "**Detergent AC Relay 1- ON During Cycle**" option. If not selected, the dosing pump will not start.

After completing the above settings, the equipment will automatically clean according to the Washing time, Recovery Delay time and Interval time set at the bottom of the interface.

- Washing Time: When the equipment enters the cleaning mode, the Flush Valve will close the sample water flow and allow fresh water to enter the system and clean the sensor and brush according to the blue arrow, while detergent will be continuously added to the fresh water stream. Here, the time required for cleaning can be set. In "**Washing Time**", the measurement value on the main interface will be locked to the previous measurement value.
- Recovery Delay Time: The Flush Valve will switch back to enable sample water flow allowing only the on-site sample water to enter the analyzer. To prevent measurement errors caused by flushing water, the recovery of the measurement values will be delayed. When the "**Recovery Delay**" time is completed, the main interface display value will be refreshed and the measured value will be re-displayed.

NOTE If you select "Discharge Selection" as "Waste", after the washing time is completed, the discharge will continue to flush to waste until the "Recovery Delay Time" is over to switching back to system to void all detergent from the line.

- Interval Time: The interval between two cleanings can be set according to the site conditions

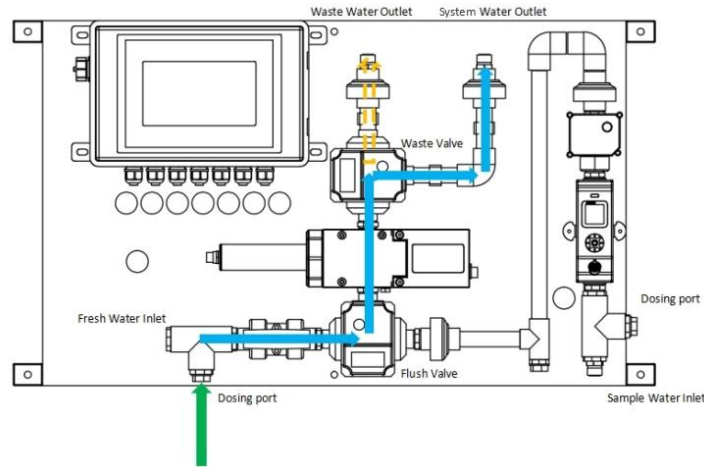

Figure. 44 – Fresh Water Cleaning

Sample Water Cleaning Cycle

In automatic mode, select "**Sample Water Cleaning**" as the cleaning mode to clean the entire sample line network including flow meter, piping, valve, sensor and brush assembly through injection of detergent on a timed cycle. During the cleaning process, the water flow will follow the direction shown in Figure 45. At the same time, you can choose to discharge the water to Waste or Sample, based on the specific application needs. In this state, please connect the detergent dosing pump to (Detergent AC Relay 1 plug pigtail) and the chemical pump discharge to the green arrow indicated in the Figure 45 diagram and select the "**Detergent AC Relay 1-ON During Cycle**" option. If not selected, the dosing pump will not start.

After completing the above settings, the equipment will automatically apply detergent according to the Washing time, Recovery Delay time and Interval time set at the bottom of the interface.

- Washing Time: When the equipment enters the cleaning mode, the Flush Valve remains closed and only active water sample will flow while continuously adding detergent. Here, you can set the time required for cleaning. In "**Washing Time**", the measurement value on the main interface will be locked to the previous measurement value.
- Recovery Delay Time: The addition of detergent will stop, and only the water sample will enter the system. To prevent measurement errors caused by the flushing water, the recovery of the measurement value will be delayed. When the recovery delay is completed, the main interface display value will be refreshed and the measured value will be re-displayed.

NOTE If you select "Discharge Selection" as "Waste" ,after the washing time is completed, the discharge will continue to flush to waste until the "Recovery Delay Time" is over to switching back to system to void all detergent from the line.

- Interval Time: The interval between two cleanings can be set according to the site conditions

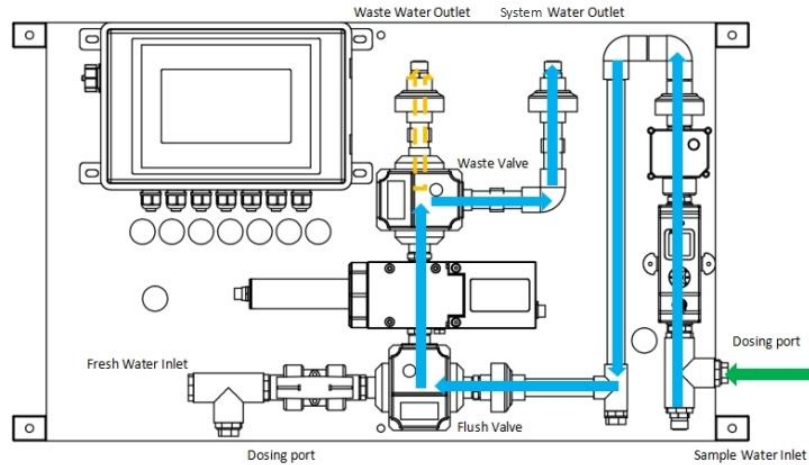

Figure. 45 – Sample Water Cleaning

b) Manual (Continuous) Mode

In some application scenarios the user may desire to feed a low level of detergent to the system all the time. This is particularly true if the cleaning agent used at the site does not affect the measurement results. The Oxipanel offers the user you to switch to the **"Manual Mode"** and connect the detergent dosing pump to (Detergent AC Relay 1 plug pigtail) and the chemical pump discharge to the position indicated by the green arrow in the Figure 47. At the same time, select the **"Sample Water Detergent"** option on the Cleaning Control interface. The water sample will flow as shown by the blue arrow in Figure 47 and will be discharged through **"Sample"**.

****IMPORTANT NOTE**** *In this format, when Oxipanel is in operation and measuring sample water, the equipment will continuously add detergent and the values displayed on the main interface will show the measured values in real time.*

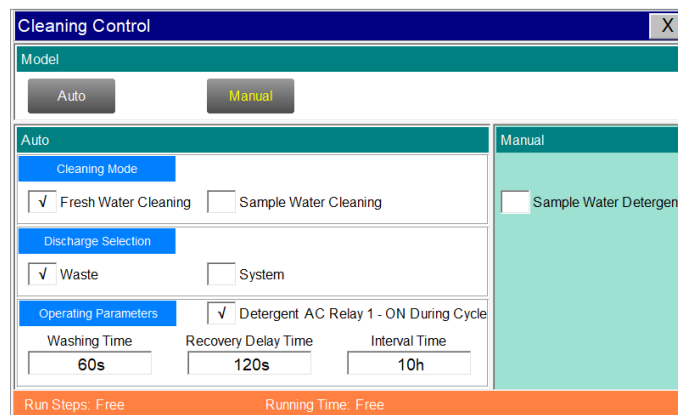

Figure. 46 – Manual Cleaning Mode

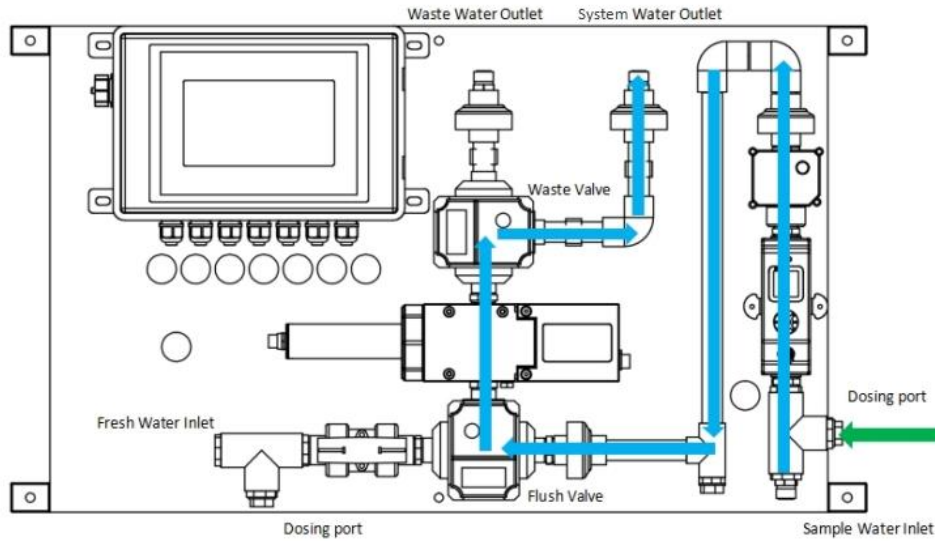

Figure. 47 – Manual (Continuous) Cleaning Mode

8.6.2. Settings Interface

Clicking on "Settings Interface" tab opens a sub-menu for Alarm Parameters and Sensor Parameters.

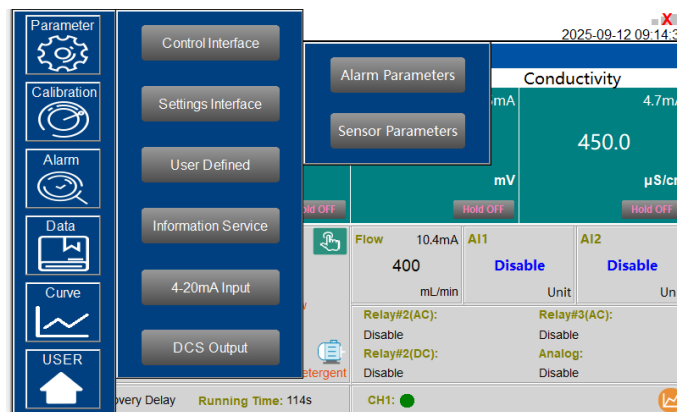

Figure. 48 –Setting Interface

Alarm Parameters Setting

Users can set the upper and lower alarm limits. Click **"Alarm Parameters"** to enter the alarm parameter settings. When the measured sensor value is lower than the set lower limit (the XX lower limit alarm) or when the measured value is higher than the set upper limit (the XX upper limit alarm), the corresponding sensor alarm will be displayed on the real-time monitoring screen. The user can also choose to turn the alarm display on or off at the top right of the corresponding parameter list.

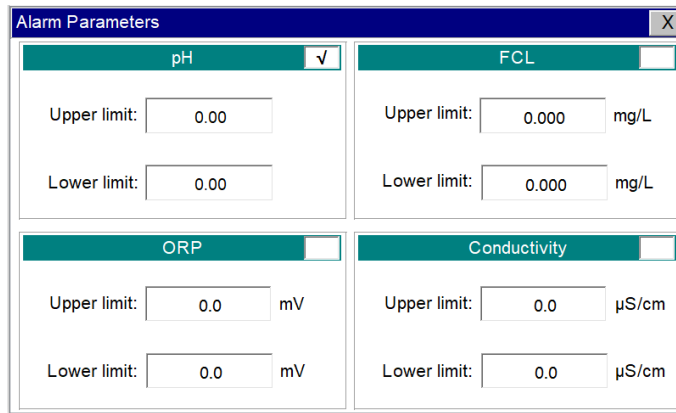

Figure. 49 - Alarm Parameter Setting

Sensor Parameters - Smoothing Factor Description & Adjustment

In **"Sensor Parameters"** within the **"Settings Interface"** field of the **"Parameter"** menu, users can set the smoothing coefficient for the sensor. Usually the oxidant concentration (e.g., free chlorine) is a very small signal, which is easily subject to external interference. The ST-766SS Series sensors adopt a continuous smoothing and averaging algorithm to filter out these minor interferences. A suitable smoothing factor setting can allow users to obtain a high-quality measurement and suitable dynamic response based on the application needs. The smoothing factor setting regulates the speed of sensors response.

The higher the smoothing factor value, the faster the sensor response and the lower the interference and noise suppression enabling a more rapid response to any changes of the real value. The lower the smoothing factor value, the slower the sensor response and the better the interference and noise suppression, but the slower the response to the real value change.

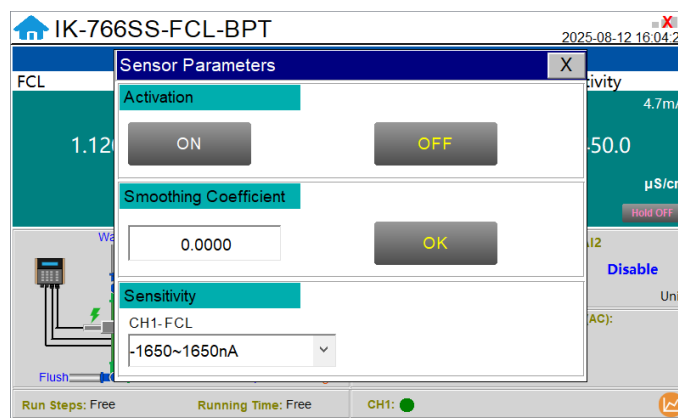

Figure. 50 -Sensor Parameters

Pyxis Lab uses the term **"T90"** when the measured value of the sensor reaches 90% of the true value to describe the speed of the sensor response in seconds. The default smoothing factor of ST-766SS Series

sensor is **0.0024 (T90≈4 minutes)**. The available setting range of the smoothing factor is 0.001 to 0.9. The following table outlines the comparison between the smoothing factor and T90 for the ST-766SS Series sensor and should be used if considering an adjustment to the smoothing factor settings.

Smoothing Factor	T90 (Seconds)
0.1	5.5
0.09	6
0.08	7
0.07	8
0.06	9.25
0.05	11.25
0.04	14
0.03	19
0.02	28.5
0.01	57.25
0.009	63.75
0.008	71.75
0.007	82
0.006	97.5
0.005	114.75
0.004	143.5
0.003	191.5
0.002	287.5

$$T_{90} \approx 0.538 * Smooth_factor^{-1.013}$$

NOTE The smoothing coefficient is not available when the sensor is in calibration mode.

8.6.3. User Defined Settings

The “User Defined” setting function allows users to assign a customized name, unit of measure and analyzer type used to any of the ST-766SS Series sensor channel inputs displayed on the OxiPanel PLATINUM.

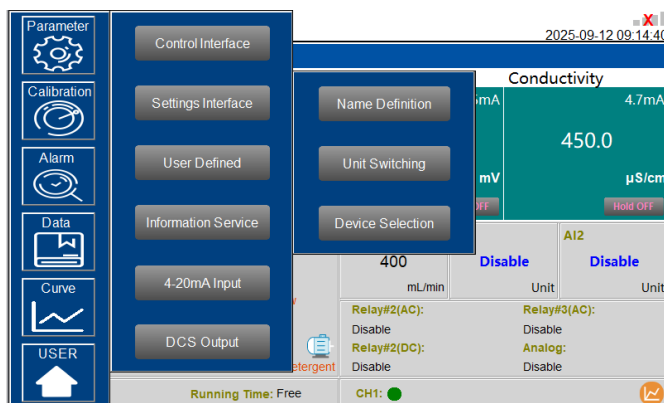

Figure. 51 – User Defined Settings

Parameter Name Definition

Click the orange dialog box to customize the sensor name.

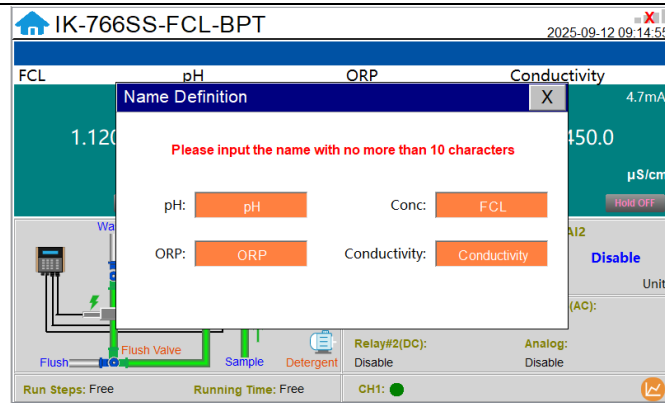

Figure. 52 - Name Definition

Unit of Measure Switching

Users can change the unit of temperature and flow rate in "Unit Switching".

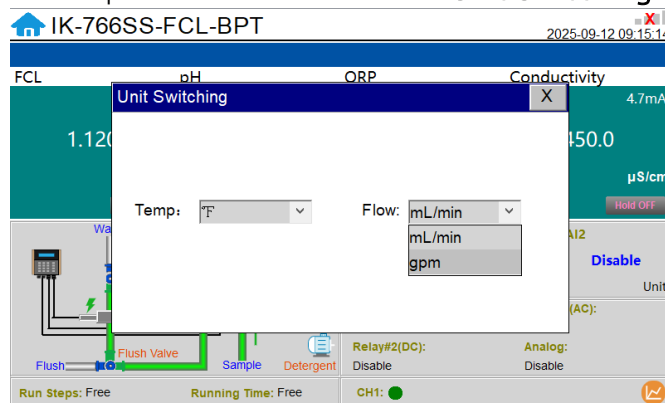

Figure. 53 - Unit of Measure Switching

Device Selection

The OxiPanel PLATINUM is shipped with the correct device selected, if an alternate sensor is desired due to application change, the new corresponding device can be selected here.



Figure. 54 – Device Selection

8.6.4. Information Service

Clicking on "Information Service " opens a sub-menu for Diagnostic Data , IO Monitoring , Terminal Definition and IoT info.

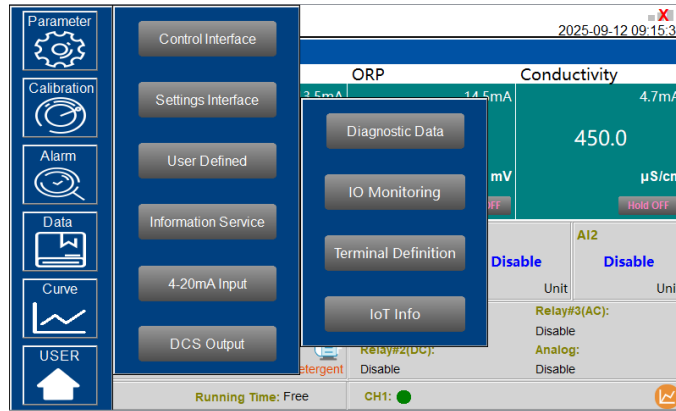

Figure. 55 – Information Service

Diagnostic Parameters for Troubleshooting Support

Click “**Diagnosis Data**” to enter the diagnosis page. In the diagnosis page, the raw data measured by the probe is displayed. To help troubleshooting possible issues with the probe, please take an image of this data when the probe is placed in a clean water (tap water or deionized water), in a standard, and in the sample that the probe is intended for. These images may be sent to service@pyxis-lab.com for troubleshooting support.

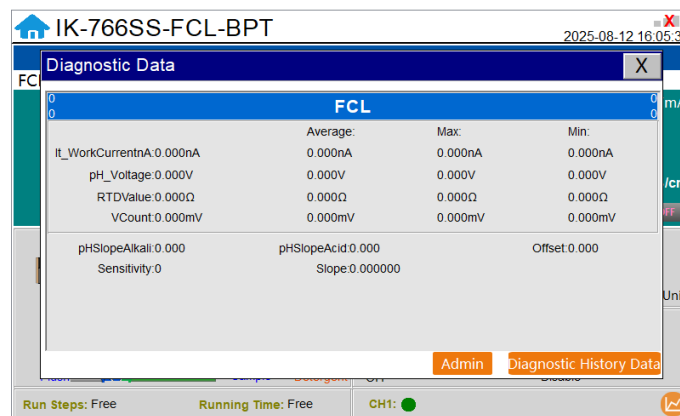

Figure. 56 - Diagnostic Parameters

Click on “**Diagnostic History Data**” in the lower right corner to access to view previous diagnostic parameters. Data can also be exported and made available for support from the Pyxis Lab Service Department.

Name	Parameter
AC 1(CN11)	Cleaning Pump
AO1(CN3)	See Table. 2
AO2(CN3)	See Table. 2
AO4(XT1/XT2)	Flow
AO6(XT5/XT6)	Conductivity
AO7(XT7/XT8)	Analog

Table. 1 - IO port definition

Type	Analog Output	Define
IK-766SS-FCL-BPT IK-766SS-CLO-BPT IK-766SS-Br-BPT IK-766SS-TCL-BPT IK-766SS-PAA-BPT IK-766SS-NCL-BPT	AO1	ORP
	AO2	pH
IK-766SS-DCL-BPT	AO1	pH
	AO2	Sulfite
	AO3	FCL
IK-766SS-TFCL-BPT	AO1	pH
	AO2	FCL
	AO3	TCL

Table. 2 - IO port definition_2

Terminal Definition

This interface shows the terminal definitions of the terminal block.

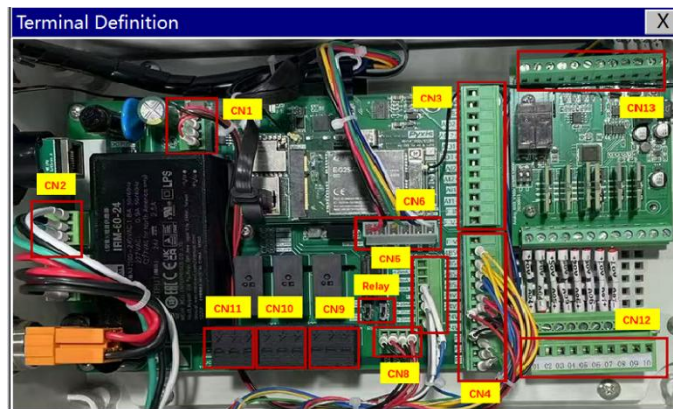

Figure. 60 - Terminal Definition

Clicking on the corresponding position can display the table defined by the corresponding terminal block.

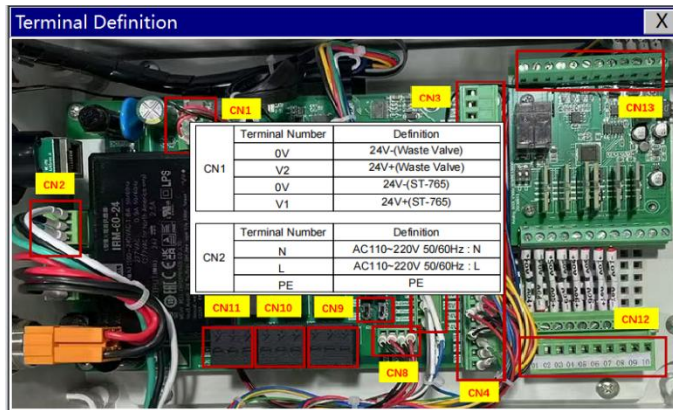

Figure. 61 - Terminal Definition Detail Diagram

Internet of Things (IOT) Info

This interface displays information related to the 4G gateway and the status of the connection. The device has been installed with a 4G gateway which arrives deactivated and may only be activated upon user request and purchase of the Pyxis data plan.

NOTE Please contact order@pyxis-lab.com or service@pyxis-lab.com for activation details.

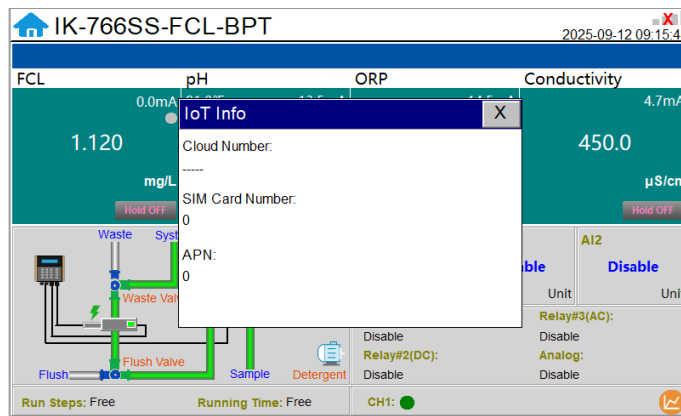

Figure. 62 - IOT Info

8.6.5. 4-20mA Input

Click "4-20mA Input" to enter the 4-20mA input parameter setting interface. The 4mA and 20mA input values should correspond to the default lower and upper limits of the device (i.e. sensor) range. These values may be adjusted by the user as desired. Names and units can be set and displayed on the real-time monitoring interface.

NOTE The closer the value is set to the measurement value the more accurate the data. It is recommended to set according to the range of the device or sensor.

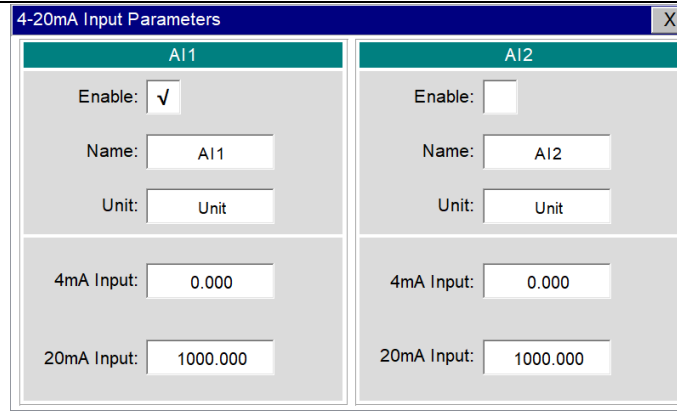

Figure. 63 - 4-20mA Input Parameters

8.6.6. DCS Output

Clicking on "DCS Output " opens a sub-menu for 4-20mA Output , Modbus RTU , Modbus TCP.

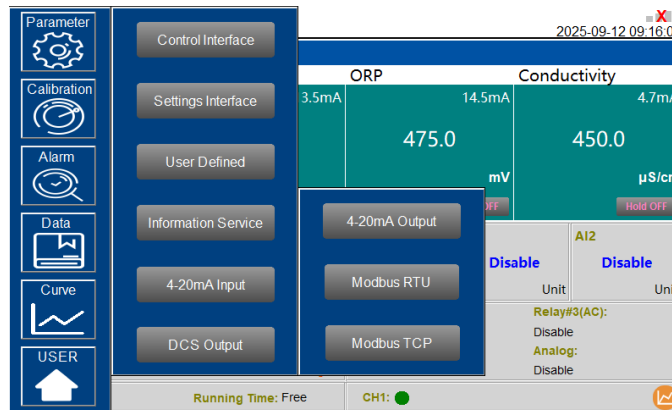

Figure. 64 - DCS Output Setting

4-20mA Output Parameter Settings & Adjustment

Click "4-20mA Output" to enter the 4-20mA output parameter setting interface. The 4mA and 20mA output values should correspond to the default lower and upper limits of the sensor range. These values may be adjusted by the user as desired.

NOTE The closer the value is set to the measurement value the more accurate the data. It is recommended to set according to the range of the sensor.

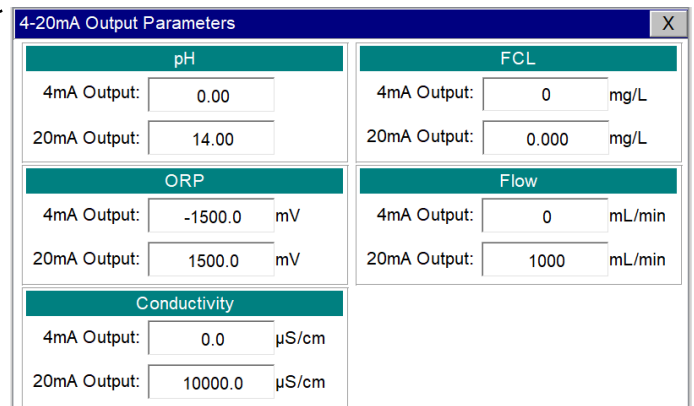

Figure. 65 - 4-20mA Output Setting

UC-80-PLUS Modbus Communication Settings

If the site desires to connect the UC-80-PLUS outputs to a DCS (Distributed Control System) for the purposes of information and process control, users can connect the master station device to the UC-80-PLUS through the HMI (Human Machine Interface) terminal and read the data according to the parameter register table provided in Section 9.1 of this manual)

Modbus RTU (RS-485) and Modbus TCP and Ethernet Address settings are preset but may be altered by the user as desired.

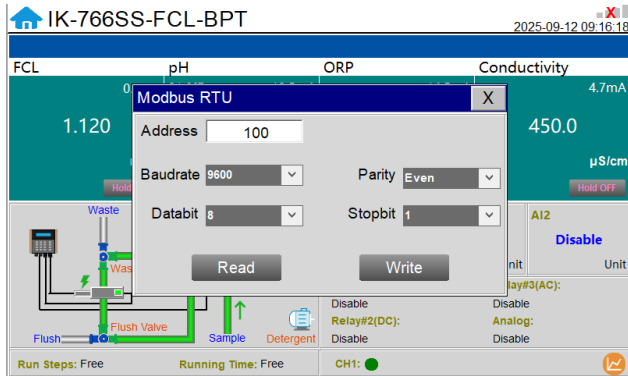

Figure. 66 - Modbus RTU

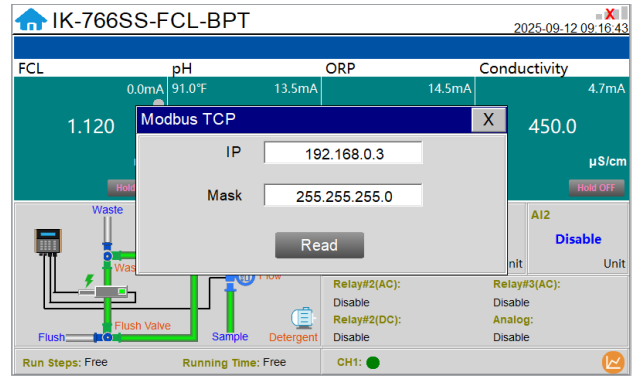

Figure. 67 - Modbus TCP

8.7. ST-766SS Series Sensor Calibration

Click on the "Calibration" button in the menu bar and select the sensor function desired for calibration.

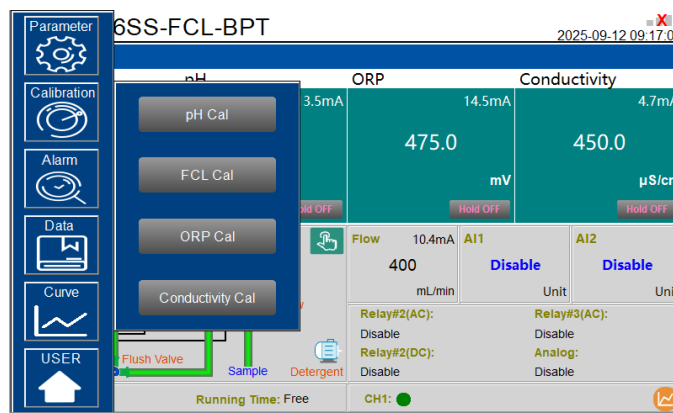

Figure. 68 - Sensor Calibration

8.7.1. pH Calibration

The pH function is thoroughly calibrated at the Pyxis Lab factory prior to shipment. After removing the sensor and checking it with a pH standard buffer solution in a beaker, if the sensor value has shifted, then the user may choose from single-point, two-point or three-point calibration to re-calibrate the pH portion of the ST-766SS sensor as desired. Pyxis Combo pH 4-7-10 Calibration Standard Kit (P/N:57007) or similar is suggested.

NOTE Click the Recovery button in the calibration interface of the sensor to restore the factory calibration settings if a user error is made during calibration and other operations. This will restore the factory settings of the sensor through this function.

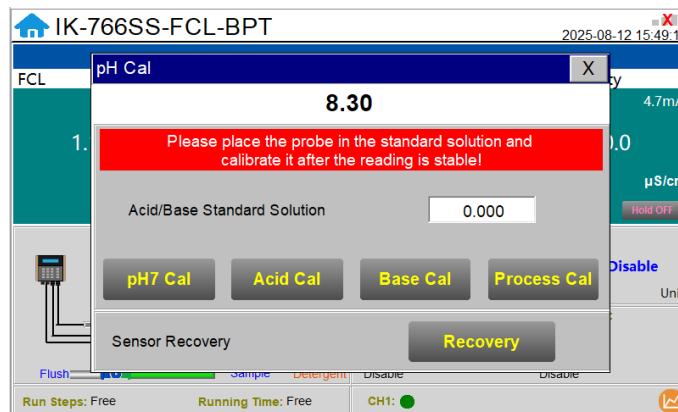

Figure. 69 - pH Calibration

Single Point pH Calibration

Remove the ST-766SS sensor and rinse 3x with DI water ensuring there is no debris or fouling of the sensor electrode head. Submerge the sensor into a beaker with pH=7 buffer solution. Click "**pH7 calibration**". A dialog box will pop up to confirm whether to perform this operation, click "OK" if the calibration operation is confirmed, if the calibration is successful the dialog box will show "**Calibration Success.**"

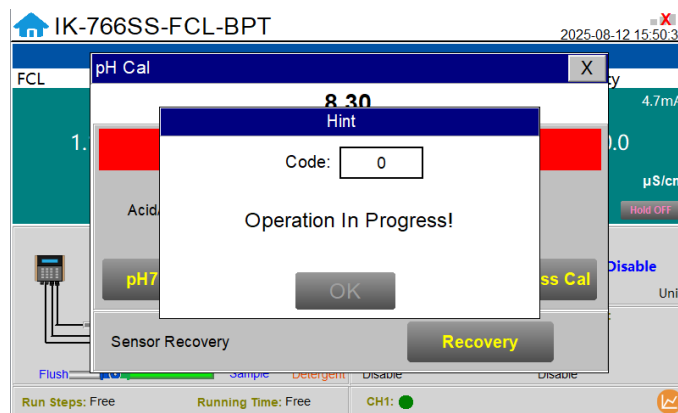

Figure. 70 – pH Calibration Prompt

A Process Calibration can be used if the pH calibration standard is not readily available for high, mid, and low calibration, or if there is a fixed deviation between the actual water sample and the true value after the user has done the calibration test. The pH process calibration is actually a correction (-0.5 to 0.5 pH units) made to the true pH value as measured by the sensor.

IMPORTANT NOTE - Anything outside this range will require a formal calibration using pH calibration standard solution.



Figure. 70 - pH Calibration Value Input

Two Point pH Calibration

Remove the ST-766SS sensor and rinse 3x with DI water ensuring there is no debris or fouling of the sensor electrode head. Submerge the sensor into a beaker with pH=7 buffer solution. Click "**pH7 calibration**". A dialog box will pop up to confirm whether to perform this operation, click "**OK**" if the calibration operation is confirmed, if the calibration is successful the dialog box will show "**Calibration Success**".

After pH7 is successfully calibrated, you can choose Acid Calibration or Alkali Calibration for the second calibration point. If you choose Acid Calibration, clean beaker 3x with deionized water. Fill the beaker with pH=4 buffer solution. Enter the value 4 in the calibration value dialog box, and click "**Acid Calibration**", then a dialog box will pop up to confirm whether to perform this operation. Click "**OK**" if the calibration operation is confirmed and the dialog box will show "**Calibration Successful**" if the calibration is successful. Similarly a pH=10 buffer solution can be selected for the second point calibration if desired.

Three Point pH Calibration

Remove the ST-766SS sensor and rinse 3x with DI water ensuring there is no debris or fouling of the sensor electrode head. Submerge the sensor into a beaker with pH=7 buffer solution. Click "**pH7 calibration**". A dialog box will pop up to confirm whether to perform this operation, click "**OK**" if the calibration operation is confirmed, if the calibration is successful the dialog box will show "**Calibration Success**".

After pH7 is successfully calibrated, you can choose Acid Calibration or Alkali Calibration for the second calibration point. If you choose Acid Calibration, rinse the beaker 3x with deionized water. Fill the beaker with pH=4 buffer solution. Enter the value 4 in the calibration value dialog box, and click "**Acid Calibration**", then a dialog box will pop up to confirm whether to perform this operation. Click "**OK**" if the calibration operation is confirmed and the dialog box will show "**Calibration Successful**" if the calibration is successful.

After successful Acid Calibration, select pH=10 for Alkali Calibration. Rinse the beaker 3x with deionized water. Fill the beaker with pH=10 buffer solution. Enter the value 10 in the calibration value dialog box, and click "**Alkali Calibration**", then a dialog box will pop up to confirm whether to perform this operation. Click "**OK**" if the calibration operation is confirmed and the dialog box will show "**Calibration Successful**" if the calibration is successful. The three-point calibration is completed.

8.7.2. Oxidizer Calibration

The oxidizer measurement module of the ST-766SS sensor is thoroughly calibrated at the Pyxis Lab factory according to the specific oxidant being measured. OxiPanel PLATINUM is offered in FCL (Free Chlorine), TCL (Total Chlorine), TFCL (Free + Total Chlorine), Br (Bromine), CLO2 (Chlorine Dioxide), PAA (Peracetic Acid) and DCL (F/T Chlorine + Sulfite) sensor formats based on sensor type.

To calibrate the sensor, the user can perform a Single-Point or Two-Point calibration according to the requirements of the application. (USEPA-334.0 / ISO-7393 compliant methodology).

Single Point Oxidizer Calibration (In-Situ)

Use a portable or laboratory colorimeter (ie. Pyxis OxiPocket SP-200, Pyxis SP-800 or similar) to test the oxidizer concentration value of the active (flowing) water sample in the OxiPanel PLATINUM flow reservoir. DPD or other appropriate methodology is recommended. Once you have tested and confirmed the oxidizer concentration value in the active (flowing) flow reservoir, enter the test result value of the colorimeter into the calibration screen in the **Process Calibration**. Please note, the label name of oxidizer being measured will be displayed in the upper left corner of this screen based on the model of OxiPanel PLATINUM and ST-766SS sensor format (ie. FCL for Free Chlorine) Once the measured oxidizer value has been entered, click "**Process Calibration**". A dialog box will pop up to confirm whether to perform this operation. If the calibration operation is confirmed, click "**OK**", and if the calibration is successful, the dialog box will show "**Calibration Success**".

NOTE Click the Recovery button in the calibration interface of the sensor to restore the factory calibration settings if a user error is made during calibration and other operations. This will restore the factory settings of the sensor through this function.

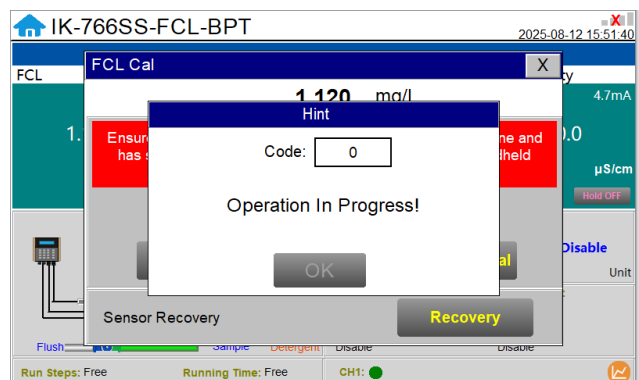
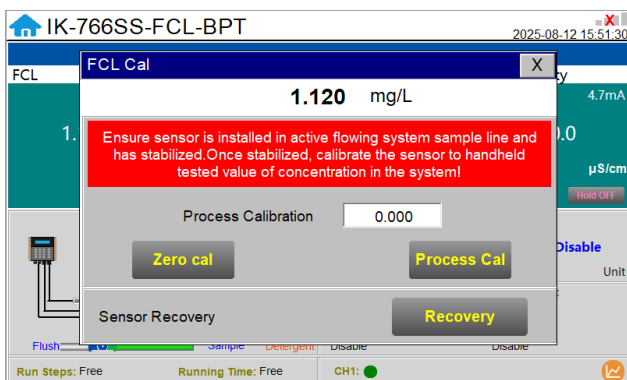

Figure. 71 – Free Chlorine Calibration of ST-766SS-FCL Figure. 72 – In Progress Screen of Free Chlorine Calibration

Two Point Oxidizer Calibration

IMPORTANT NOTE Under normal operational use of the ST766SS Series sensor, Pyxis Lab **does not suggest** a Zero-Point calibration by the user and the preprogrammed factory zero should remain unaltered. Only Slope calibration is recommended as a standard practice.

Zero-Point Calibration Procedure:

If a zero calibration is necessary, close the water inlet valve and remove the ST-766SS sensor and rinse 3x with DI water ensuring there is no debris or fouling of the sensor electrode head. Submerge the sensor into a beaker filled with Pyxis Zero Oxidizer Calibration Solution (P/N:21022) or with 100µS/cm Conductivity Standard Solution or simply hold the sensor in the air. All will work. Wait for the ST-766SS sensor oxidizer value to stabilize on the touch-screen display. Sensor stabilization should occur within few minutes. Click **"Zero Calibration"** and a dialog box will pop up to confirm whether you desire to perform this operation. Click **"OK"** to confirm the calibration operation. If the calibration is successful, the dialog box will show **"Calibration Success"**. The sensor is now zero-calibrated to the known zero calibration solution.

Slope-Point Calibration Procedure:

After successful zero calibration, insert the ST-766SS Series sensor back into the FR-306-PLUS and open the sample water supply valve allowing the sensor to read and stabilize after a few minutes of observation. Use a portable or laboratory colorimeter (ie. Pyxis OxiPocket SP-200, Pyxis SP-800 or similar) to test the oxidizer concentration value of the active (flowing) water sample in the OxiPanel PLATINUM flow reservoir. DPD or appropriate methodology is recommended. Once you have tested and confirmed the oxidizer concentration value in the active (flowing) flow reservoir, enter the test result value of the colorimeter into the calibration screen in the **Process Calibration**. Please note, the label name of oxidizer being measured will be displayed in the upper left corner of this screen based on the model of OxiPanel PLATINUM and ST-766SS sensor format (ie. FCL for Free Chlorine) Once the measured oxidizer value has been entered, click **"Process Calibration"**. A dialog box will pop up to confirm whether to perform this operation. If the calibration operation is confirmed, click **"OK"**, and if the calibration is successful, the dialog box will show **"Calibration Success"**.

NOTE Click the Recovery button in the calibration interface of the sensor to restore the factory calibration settings if a user error is made during calibration and other operations. This will restore the factory settings of the sensor through this function.

8.7.3. ORP Calibration

Close the water inlet valve and remove the ST-766SS sensor and rinse 3x with DI water ensuring there is no debris or fouling of the sensor electrode head. Submerge the sensor into a beaker filled with Pyxis ORP-200 Calibration Standard Solution (P/N: 57020) or similar. Enter the known concentration of the ORP standard solution in the calibration screen and click **"Calibrate"**. A dialog box will pop up to confirm whether to perform this operation. If the calibration operation is confirmed, click **"OK"**. If the calibration is successful, the dialog box will display **"Calibration Successful"**.

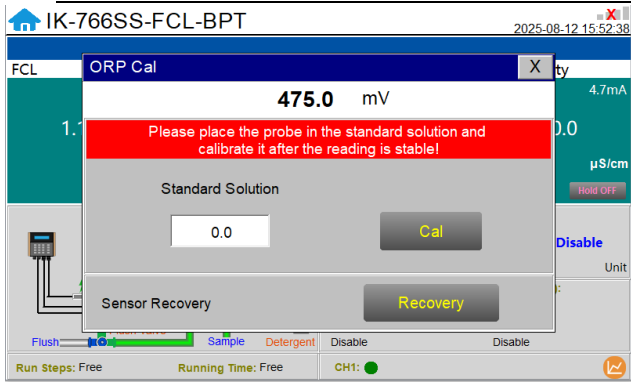

Figure. 73 - ORP Calibration

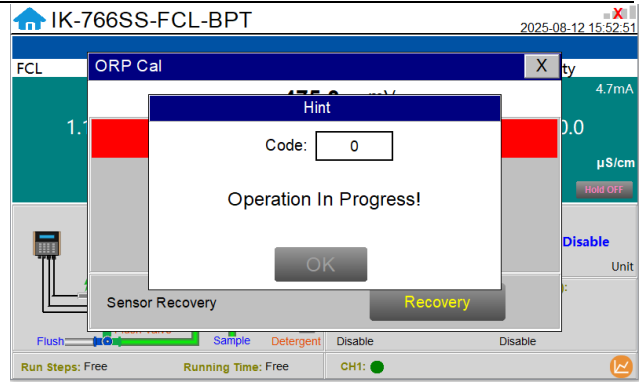

Figure. 74 - Awaiting Execution Screen

8.7.4. Conductivity Calibration

The conductivity sensor only needs to be calibrated once, put the sensor into the standard solution with known standard solution value, Pyxis 1,000uS/cm Conductivity Standard (P/N 57008) ,or use a handheld device to measure the conductivity value of the on-site water sample.and enter the standard solution value in the interface, then click calibration, wait for the calibration completion prompt to pop up, which means the calibration is successful.

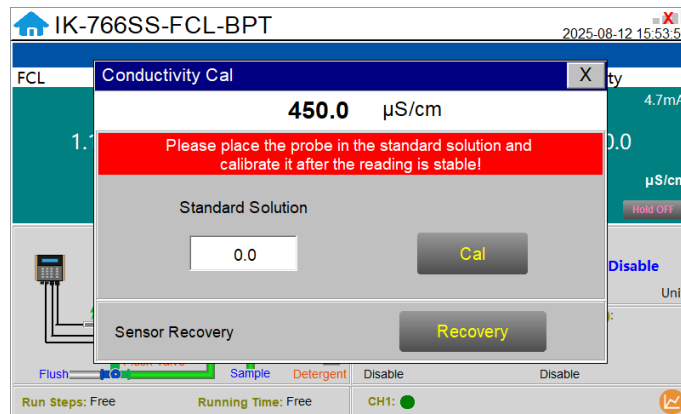

Figure. 75 - Conductivity Calibration

NOTE Click the Recovery button in the calibration interface of the sensor to restore the factory calibration settings if a user error is made during calibration and other operations. This will restore the factory settings of the sensor through this function.

8.7.5. Recovering Data

Click the restore button in the calibration interface of each sensor to restore the data of sensors. If a user error is made during calibration and other operations, you may restore the factory settings of the sensor through the restore function.



Figure. 76 -Restore Factory Settings

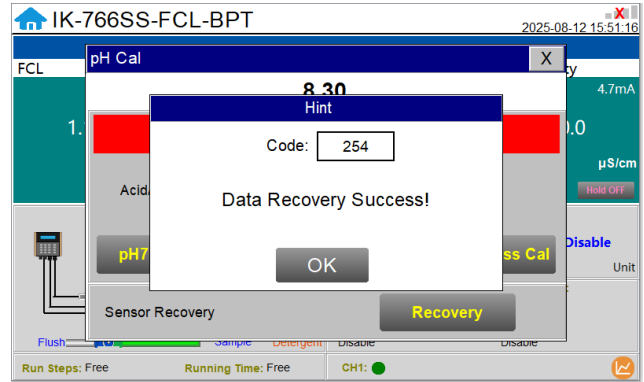

Figure. 77 – Data Recovery Success

8.8. Alarm View

Click the "Alarm View" button on the main screen to enter the alarm view screen.

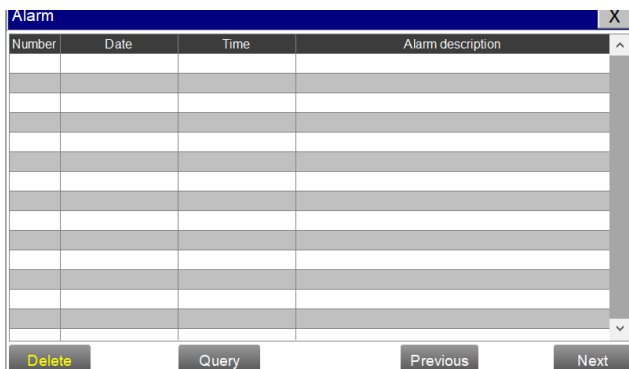

Figure. 78 - Alarm View

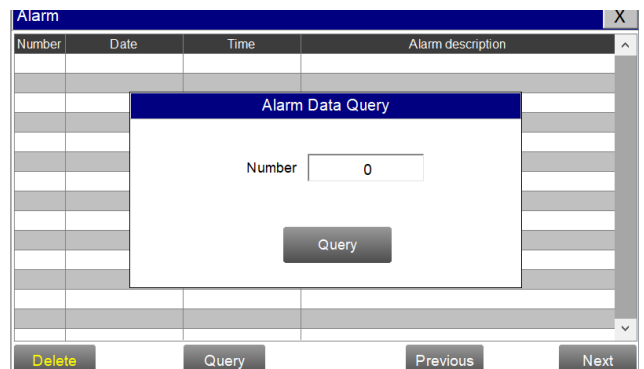

Figure. 79 - Alarm Data Query Screen

In this screen users can browse all logged alarms. Drag the right scroll bar up and down to view the history of alarms. Click "Previous" and "Next" to advance to the next page. Click "Query" then enter the alarm number in the pop-up box to query that alarm. The Delete button in the lower left corner will delete all alarm records. After clicking delete, you must exit the screen and reenter before the historical data within the data report will be cleared.

8.9. Historical Data – Query, View & USB Download

Click on "Data" to view historical data and calibration logs.

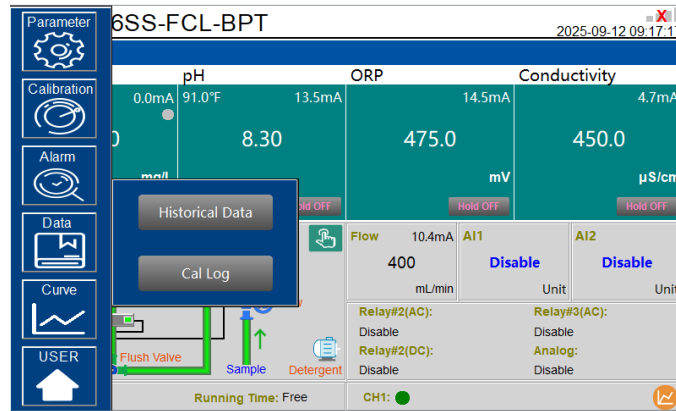

Figure. 80 – Data

Historical Data

Click the "Historical Data" button in the menu bar to enter the data report interface.

Number	Time	Conc	pH	ORP
1	2025-08-12 15:47:14	1.120	8.30	475.0
2	2025-08-12 15:46:14	1.120	8.30	475.0
3	2025-08-12 15:45:14	1.120	8.30	475.0
4	2025-08-12 15:44:14	1.120	8.30	475.0
5	2025-08-12 15:43:14	1.120	8.30	475.0
6	2025-08-12 15:42:14	1.120	8.30	475.0
7	2025-08-12 15:41:14	1.120	8.30	475.0
8	2025-08-12 15:40:14	1.120	8.30	475.0
9	2025-08-12 15:39:14	1.120	8.30	475.0
10	2025-08-12 15:38:14	1.120	8.30	475.0

Figure. 81 - Historical Data Screen

In the data report, the user can view the stored data of all parameters. The system records sensor readings every 4 seconds by default but this can be edited by the user if desired. Drag the scroll bar on the right to slide up or down or click "Previous" and "Next" to view historical data records. The data record can save up to 100,000 data entries. New data will overwrite the previously saved data after recording 100,000 data entries. The user can click the "Periodicity" button to change the data recording time interval. Click "Delete" in the lower left corner. After entering the retention time, click the "Delete" button to clear all historical data within the retention time range.

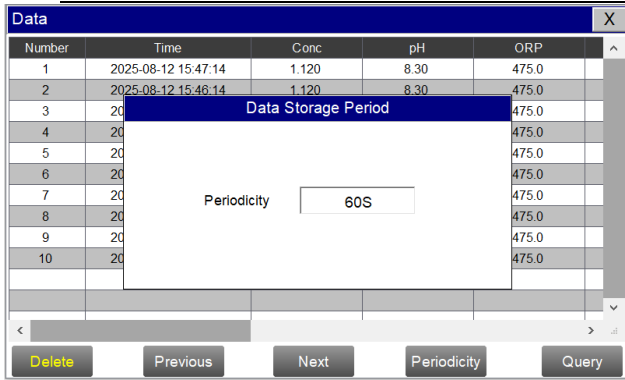
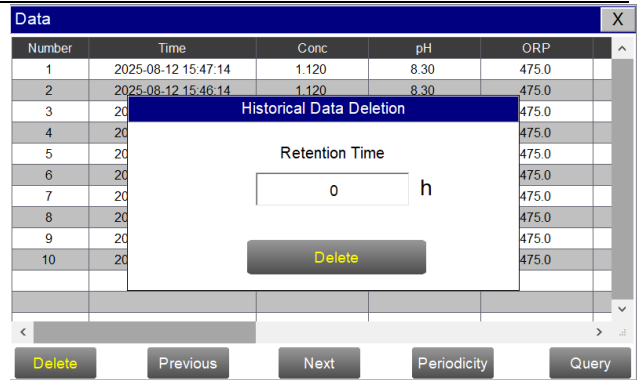

Figure. 82 - Data Storage Cycle Time Setting Figure.



83 - History Data Deletion Screen

Click the **“Query”** button in the lower right corner, enter the start time and end time and then click the **“Query”** button.

NOTE The start time and end time must be filled in exactly and completely according to the system time format of Year / Month / Day / Hours / Minutes / Seconds.

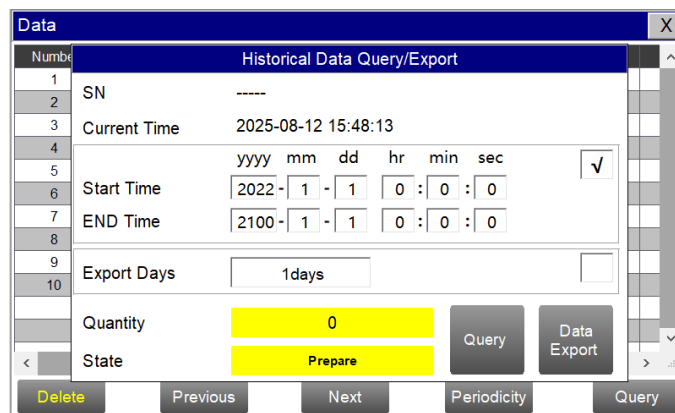

Figure. 84 - Historical Data Query and Export Screen

Insert a USB disk behind the HMI display screen and enter the time range of the data to be exported in the query area. Click on the **“Data Export”** to download the data to the USB disk. The data quantity will be shown as a positive number if data export is successful. If the data export was not successful, please check whether the time format is correct.

NOTE Please be sure to use and empty (no saved files) FAT32 formatted USB disk with data capacity of 32-64GB.

When a **Quantity** value appears, refer to the following table to troubleshoot the issue.

Quantity	Description
-1001	Progress or control data object type is incorrect
-1004	Group object name does not exist or the group object does not have the save property
-1020	The start time of the export is greater than the end time
-1021	USB flash drive is not inserted
-1022	Only one export task is allowed at the same time
-1023	The number of records read is 0
-1024	File operation failed
-1025	Export path is empty
-1026	Export path is not legal
-1027	Incorrect time format
-1028	Unsupported export mode

Calibration Log

The calibration log can be viewed in the calibration log interface, and when the export operation is performed, the diagnostic parameters, historical data, and calibration log will be exported simultaneously.

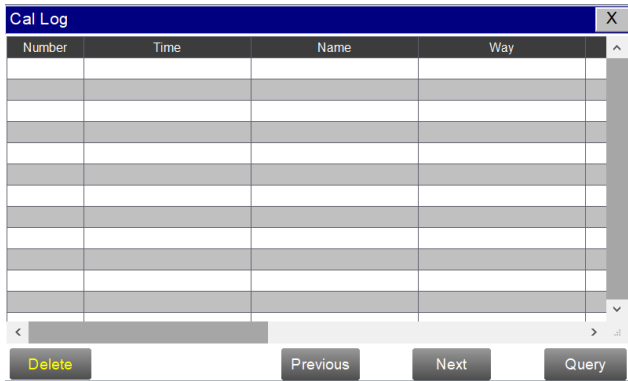

Figure. 85 - Calibration Log

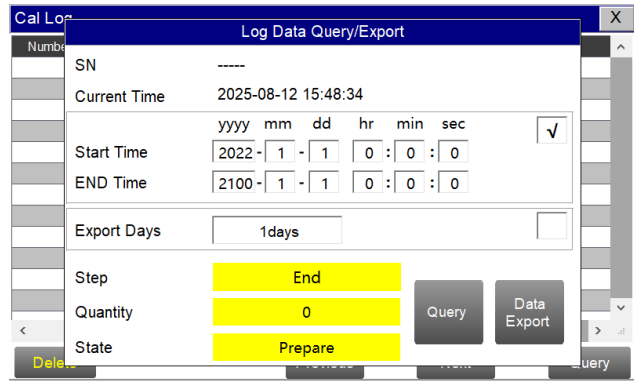

Figure. 86 - Calibration Log Query/Export

8.10. Historical Data Curves

Click the "Historical Curve" button in the menu bar to enter the trend curve interface. You can click the buttons below the X-axis to browse and view the values in a different time range. Click on Y-axis Range to change the minimum and maximum Y-axis values for a proper range.

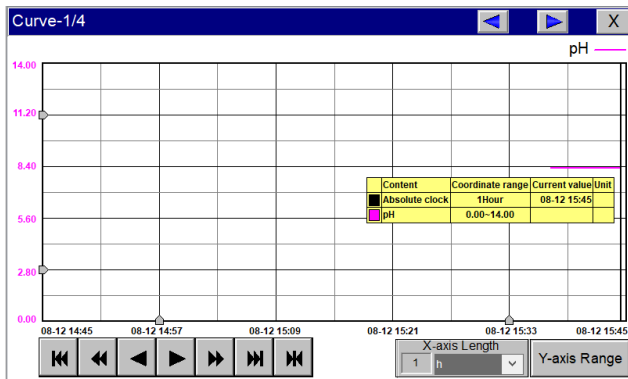

Figure. 87 - History Curve Screen

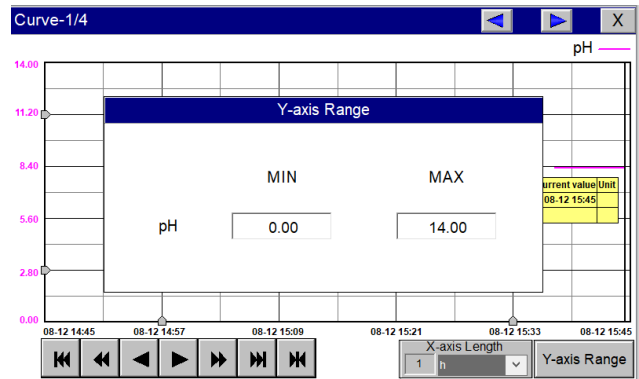

Figure. 88 - Y-axis Range Setting

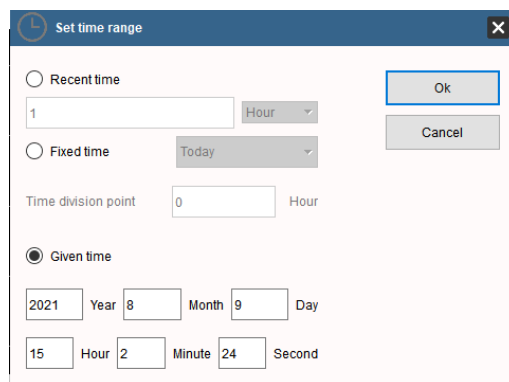

Figure. 89 - Time Setting Screen

Please refer to the button description overview for Historical Curve Function navigation.

- The curve will scroll back (to the left of the X-axis) one page
- The curve will scroll back (to the left of the X-axis) half the page of the curve
- The curve will scroll backward (to the left of the X-axis) to a position where the main line is drawn
- The curve will scroll forward (to the right of the X-axis) to a position where the main line is drawn
- The curve will scroll forward (to the right of the X-axis) half the page of the curve
- The curve will scroll forward (to the right of the X-axis) one page
- A dialog box will pop up to reset the starting time of the curve

Figure. 90 - Button Function Review

8.11. User Management

Click the "User" button on the menu bar and then you can select "Login", "Logout" and "Manage" operations.

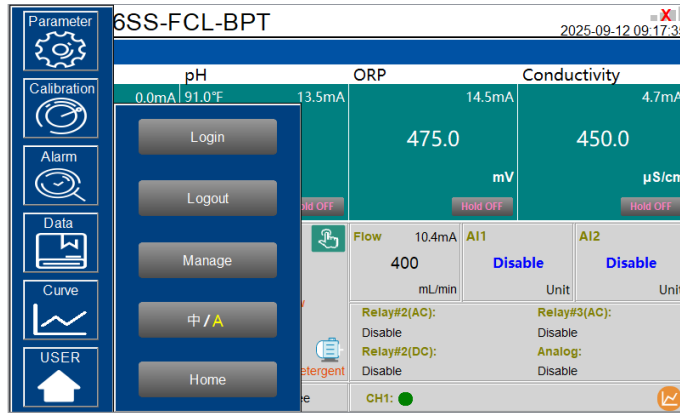

Figure. 91 - User Management

Logout enables the user to log out of the logged-in state and only view the real-time readings, but cannot perform operations such as parameter settings. Click **"Manage"** to enter the user management interface, where you can add users, change passwords and other operations. Users can set their own user name and password and select the user group they belong to. Only users in the administrator group can set parameters such as calibration.

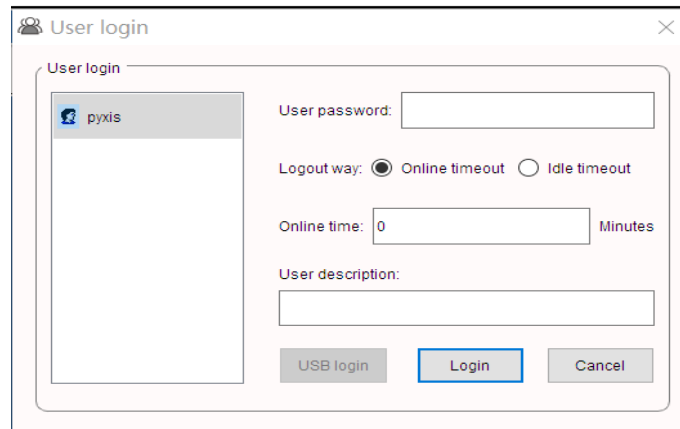

Figure. 92 - Modifying the User Screen

Modify Password: Select the user you want to change, then click **"Modify User"** button, enter the user's own password in the User Password column and Confirm Password column, and click **"Confirm"** to modify successfully.

NOTE *If you do not want to set the password, you can delete the password and save it.*

9. Modbus Register Table & Analyzer Maintenance

9.1. Modbus Correspondence Address

Serial Number	Definition	Address	Format	Mode	Unit	Note
1	Oxidizer	1	float	read-only	mg/L	Data Format ABCD
2	pH	3	float	read-only		
3	ORP	5	float	read-only	mV	
4	Conc2	7	float	read-only	mg/L	
5	Temp	9	float	read-only	°F / °C	
6	Flow	11	float	read-only	mL/min - gpm	
7	Conductivity	13	float	read-only	µS/cm	
8	Analog Input (AI1)	15	float	read-only		
9	Analog Input (AI2)	17	float	read-only		
10	Oxidizer lower limit alarm	23	uint	read-only		0: Normal 1: Alarm
11	Oxidizer upper limit alarm	24	uint	read-only		
12	pH lower limit alarm	25	uint	read-only		
13	pH upper limit alarm	26	uint	read-only		
14	ORP lower limit alarm	27	uint	read-only		
15	ORP upper limit alarm	28	uint	read-only		
16	Conc_2 lower limit alarm	29	uint	read-only		
17	Conc_2 upper limit alarm	30	uint	read-only		
18	Lower conductance alarm	31	uint	read-only		
19	Upper conductance alarm	32	uint	read-only		
20	The communication of the FCL sensor is abnormal	33	uint	read-only		
21	The communication of the liquid level sensor is abnormal	36	uint	read-only		
22	The communication between the DI collection module is abnormal	38	uint	read-only		
23	The communication between the control module is abnormal	39	uint	read-only		
24	The relay module communication is abnormal	40	uint	read-only		
25	Brush communication anomaly	41	uint	read-only		
26	Communication between analog modules is abnormal	42	uint	read-only		
27	Analog module communication is abnormal_2	43	uint	read-only		
28	Brush_malfunction	44	uint	read-only		
29	Low_flow	45	uint	read-only		
Communication Protocol: Standard Modbus-RTU						
Communication Parameters: Baud Rate - 9600 / Data Bit - 8 / Stop Bit - 1 / Parity Bit - Even						
Station Number: 100						
Communication Protocol: Standard Modbus-TCP						
Communication Parameters: IP: 192.168.0.3 (can be set); port: 502						
Station Number: 1						

Table. 3 - Modbus Correspondence Address

9.2. Analyzer Operation and Maintenance

After the analyzer is installed by a qualified technician, it can begin to monitor water quality immediately. Upon powerup of the analyzer, the ST-766SS Series sensor will always conduct a 5-minute electrode initialization process to prepare the bare-gold for service. During this time, the sensor will not read an oxidizer value. After this cycle, the sensor will begin reading the live oxidizer value. The OxiPanel PLATINUM is designed to be simple to operate, but still requires some regular maintenance. Actual system maintenance may vary depending on the installation conditions and usage. Please refer to the table below as a general recommended maintenance schedule guideline. Minimal intervention is required during normal operation.

Required Services	Recommended Frequency	Procedure Location
Cleaning Inlet Water Filter Screen	Monthly or Cleaned As Needed	NA
Cleaning of Flow Reservoir & Electrode Head	Monthly or Cleaned As Needed	Section 10.2
pH Calibration	Every 6 Months or As Needed	Section 8.7.1
Oxidizer Calibration	Every 6 Months or As Needed	Section 8.7.2
ORP Calibration	Every 6 Months or As Needed	Section 8.7.3
Conductivity Calibration	Every 6 Months or As Needed	Section 8.7.4
FR-306-PLUS Brush Replacement	Every 1-2 Years or As Needed	Section 10.1
EH-766 Electrode Head Replacement	Every 1-2 Years or As Needed	Section 10.2

Table. 4 - Maintenance Intervals

9.3. Instrument Alarms and Descriptions

Please refer to the instrument alarms and descriptions table when troubleshooting the IK-766SS-BPT inline inspection system issues an alarm or indicates abnormal measurement data.

Alarms	Description	Symptoms	Solutions/Recommendations
pH / Oxidizer Sensor Communication Abnormalities	pH / Oxidizer Sensor without Communication	No pH and Oxidizer Measurements	Check the connection between the sensor and the circuit board. If the problem persists, contact Pyxis.
pH Upper Limit Alarm	pH above the Alarm Setting	Information Only	Compare with manual measurement readings. Check and clean line valves. Check that water flow is normal. Check that the sensor is clean.
pH Lower Limit Alarm	pH below the Alarm Setting	Information Only	
Oxidizer Upper Limit Alarm	Oxidizer above the Alarm Setting	Information Only	
Oxidizer Lower Limit Alarm	Oxidizer below the Alarm Setting	Information Only	
pH/Oxidizer Calibration Failure Code 2		Calibration Failure	Check whether the water flow is normal, whether the sensor is clean, whether the standard liquid is contaminated
pH/Oxidizer Calibration Failure Code 3	Standard Solution Value out of Range	Calibration Failure	
pH/Oxidizer Calibration Failure Code 5	Wrong Data Type for the Liquid Value	Calibration Failure	

Table. 5 - Common Alarms

10. Replacement Maintenance





10.1. Replacing the FR-306-PLUS Brush Assembly

Under normal application use, the FR-306-PLUS brush replacement should be done every 1 to 2-years. This may vary depending on application and water quality. Please refer to the following process steps for replacement of the FR-306-01 (P/N : 20802) brush assembly.

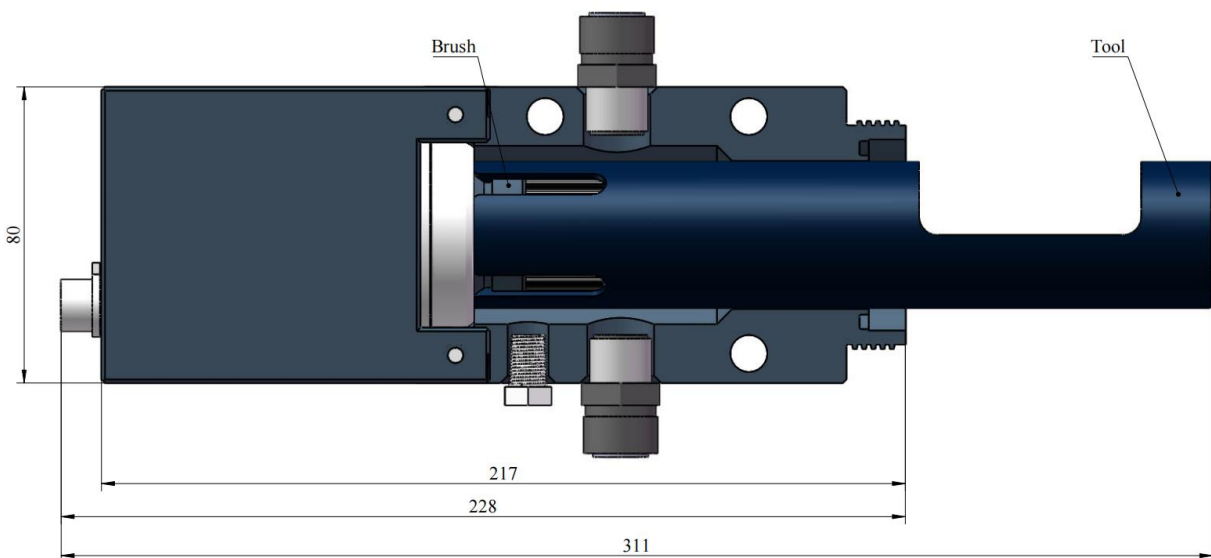
FRP-306-01 Brush Replacement Procedure using the FR-300-03 Quick-Replacement Tool

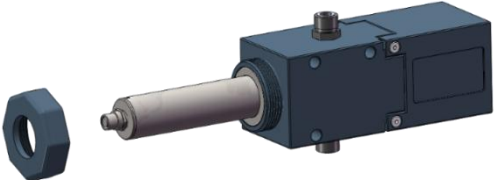
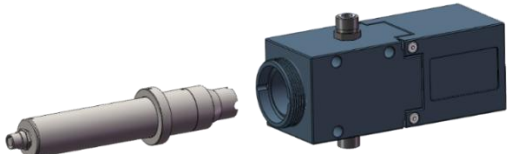
Tool Assembly Dimensions(mm)

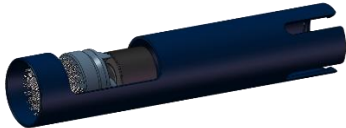
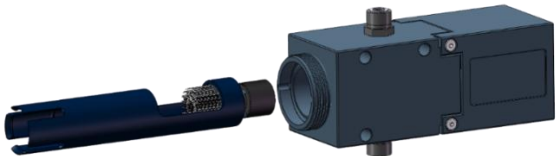

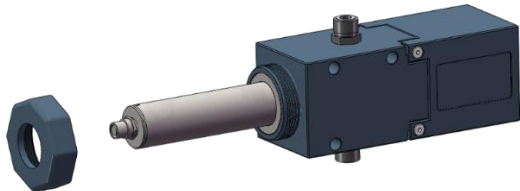
<p>STEP.1 Remove the sensor retaining nut.</p>	<p>STEP.2 Remove the sensor.</p>
	
<p>STEP.3 Insert the extraction tool with the slotted end first until the head of the tool snaps onto the collar of the brush.</p>	
	
<p>STEP.4 Remove the brush when it reaches the grooved opening.</p>	
<p>STEP.5 Fit the new brush in the tapered end position of the tool as shown in the picture and insert it into the hole, gently press on the tool until the brush has been adequately installed onto the drive shaft of the brush motor within the flow assembly, then remove the tool. Your brush has been replaced.</p>	
	
<p>STEP.6 Reinstall the sensor to the position as shown in the picture.</p>	<p>STEP.7 Reinstall the sensor retaining nut to the position shown in the picture.</p>
	

10.2. Sensor Cleaning with Pyxis Probe Cleaning Kit

In the event of heavy inorganic deposition on the ST-766SS Series electrode head, users may conduct an off line chemical cleaning using the Pyxis Probe Cleaning Kit (P/N: SER-01). Isolate the FR-306-PLUS flow reservoir from flow. Remove the ST-766SS Series sensor from the reservoir and inspect the internal components of the flow reservoir and brush head with a flash light. If necessary flush thoroughly with clean water until adequately clean or remove the brush with the Pyxis Brush Extraction Tool. If the FR-306-PLUS brush is in need of replacement, refer to Section 10.1 of this manual. Soak the lower half of the ST-766SS Series sensor in 100 mL Pyxis Probe Cleaning Solution for 10-15 minutes. Gently wipe the sensor electrode head with the provided Q-tips. If the surface is not entirely clean, continue to soak the sensor for an additional time until clean. Rinse the sensor with distilled water. Pyxis Lab Probe Cleaning Kit can be purchased at our online Estore/Catalog at <https://www.pyxis-lab.com/product/inline-sensor-cleaning-kit/>



Contact Pyxis Lab

21242 Spell Circle

Tomball, TX. 77375

service@pyxis-lab.com for technical service and support

order@pyxis-lab.com for order and pricing inquiries

1-866-203-8397 Phone USA for all needs

Office Hours 7AM – 5PM Central Time USA